

Technical training.
Product information.

G12 Driver Assistance Systems



BMW Service

Edited for the U.S. market by:

BMW Group University
Technical Training

ST1501

8/1/2015

General information

Symbols used

The following symbol is used in this document to facilitate better comprehension or to draw attention to very important information:



Contains important safety information and information that needs to be observed strictly in order to guarantee the smooth operation of the system.

Information status and national-market versions

BMW Group vehicles meet the requirements of the highest safety and quality standards. Changes in requirements for environmental protection, customer benefits and design render necessary continuous development of systems and components. Consequently, there may be discrepancies between the contents of this document and the vehicles available in the training course.

This document basically relates to the European version of left hand drive vehicles. Some operating elements or components are arranged differently in right-hand drive vehicles than shown in the graphics in this document. Further differences may arise as the result of the equipment specification in specific markets or countries.

Additional sources of information

Further information on the individual topics can be found in the following:

- Owner's Handbook
- Integrated Service Technical Application.

Contact: conceptinfo@bmw.de

©2015 BMW AG, Munich

Reprints of this publication or its parts require the written approval of BMW AG, Munich.

The information contained in this document forms an integral part of the technical training of the BMW Group and is intended for the trainer and participants in the seminar. Refer to the latest relevant information systems of the BMW Group for any changes/additions to the technical data.

Information status: **June 2015**
BV-72/Technical Training

G12 Driver Assistance Systems

Contents

1.	Introduction	1
2.	G12 Bus Overview	2
3.	KAFAS	5
3.1.	Detection range.....	6
3.2.	Person recognition.....	7
3.3.	Road sign recognition.....	8
3.4.	Lane detection.....	8
3.5.	Detection of the road condition.....	9
3.6.	Functional limitations.....	9
4.	Optional Equipment System	11
5.	Overview Of Sensors	12
6.	Intelligent Safety	14
6.1.	Overview of the configuration menu.....	16
7.	Collision Warning	19
7.1.	Functional principle.....	19
7.1.1.	Collision warning with city braking function.....	20
7.1.2.	Pedestrian warning with city braking function.....	21
7.2.	Warning and braking function.....	21
7.2.1.	Displays.....	22
7.2.2.	Early warning.....	22
7.2.3.	Acute warning.....	22
7.2.4.	Brake intervention	23
7.3.	Operation.....	25
7.4.	Limits of the system.....	27
8.	Lane Departure Warning	28
8.1.	Active steering intervention.....	30
8.2.	System wiring diagram.....	32
8.3.	Deactivation criteria.....	34
8.4.	Limits of the system.....	34
9.	Blind Spot Detection	35
9.1.	Active steering intervention.....	37
9.2.	System wiring diagram.....	39
9.3.	Limits of the system.....	40
10.	Side Collision Warning	41

G12 Driver Assistance Systems

Contents

10.1.	Limits of the system.....	44
11.	Road Sign Recognition.....	45
11.1.	Operation.....	46
11.2.	Limits of the system.....	46
12.	Proactive Active Driving Assistant.....	49
12.1.	Operation.....	52
12.2.	Limits of the system.....	53
13.	Alertness Assistant.....	54
13.1.	Operation.....	54
13.2.	Limits of the system.....	56
14.	Night Vision.....	57
14.1.	System wiring diagram.....	62
14.2.	Operation.....	64
14.3.	Limits of the system.....	65
15.	Cameras.....	66
15.1.	Surround view.....	66
15.1.1.	Automatic camera angle.....	67
15.1.2.	Side view.....	67
15.1.3.	Front camera.....	67
15.1.4.	Panorama View.....	68
15.1.5.	Reversing camera.....	72
15.1.6.	Moving camera angle.....	72
15.2.	Overview of exterior camera operating menu.....	74
15.3.	Assistant function.....	77
15.3.1.	Car wash view.....	77
15.3.2.	Side protection.....	77
15.3.3.	Door opening angle.....	78
15.4.	System components.....	79
15.4.1.	Reversing camera.....	80
15.4.2.	TRSVc control unit.....	81
15.5.	System wiring diagram.....	82
16.	Park Distance Control.....	85
16.1.	System components.....	85
16.2.	Auto PDC.....	86
16.3.	Active Park Distance Control.....	88
16.4.	Side protection.....	88

G12 Driver Assistance Systems

Contents

16.5.	Operation.....	89
16.5.1.	Auto PDC.....	89
16.5.2.	Active Park Distance Control.....	90
16.5.3.	Acoustic signal output.....	91
16.6.	Deactivation criteria.....	92
16.7.	Limits of the system.....	93
17.	Cross-Traffic Warning.....	94
17.1.	Functional principle.....	94
17.2.	Rear cross-traffic warning.....	95
17.3.	Front cross-traffic warning.....	95
17.4.	Displays.....	96
17.5.	Operation.....	97
17.6.	Limits of the system.....	98
18.	Parking Maneuver Assistant.....	99
18.1.	System components.....	99
18.2.	System wiring diagram.....	101
18.3.	Control unit.....	104
18.4.	Functional principle.....	104
18.5.	Functional prerequisites.....	105
18.5.1.	Measuring parking spaces.....	105
18.5.2.	Suitable parking spaces parallel to the roadway (parallel parking).....	106
18.5.3.	Suitable parking spaces perpendicular to the roadway (bay parking).....	108
18.5.4.	Detection of a universal parking space.....	111
18.6.	Side protection.....	112
18.7.	Operation.....	113
18.7.1.	Parking procedure (parallel parking).....	114
18.7.2.	Parking procedure (bay parking).....	116
18.7.3.	Deactivation criteria.....	118
18.8.	Limits of the system.....	118
19.	Cruise Control.....	120
19.1.	Introduction.....	120
19.2.	Cruise control with braking function.....	120
19.2.1.	Control functions.....	120
19.2.2.	Activation of the actuators.....	121
19.2.3.	Operation.....	122
19.3.	Active cruise control with Stop&Go function.....	123

G12 Driver Assistance Systems

Contents

19.3.1.	Control functions.....	126
19.3.2.	Operation.....	127
19.3.3.	System wiring diagram.....	132
20.	Speed Limit Warning.....	134
20.1.	Operation.....	134
21.	Lateral Guidance Assistants.....	135
22.	Lane & Traffic Jam Assistant.....	136
22.1.	Functional principle.....	136
22.1.1.	Hands-off-Detection.....	138
22.1.2.	Functional prerequisites.....	140
22.1.3.	Lane change.....	141
22.1.4.	Function logic.....	141
22.1.5.	Steering interventions.....	142
22.1.6.	Operation.....	143
22.1.7.	System wiring diagram.....	145
22.1.8.	Deactivation criteria.....	147
22.1.9.	Limits of the system.....	147
23.	Active Lane Keeping Assistant.....	148
23.1.	Side collision warning.....	148
23.1.1.	Reduced side collision warning.....	148
23.2.	Lane departure warning.....	149
23.3.	Blind spot detection.....	150

G12 Driver Assistance Systems

1. Introduction

The range of existing assistance systems has been expanded in the G12 to include new innovative systems. The interplay between the varied and intelligent assistance systems supports the driver in every respect; from making driving more comfortable to providing the reassuring feeling of safety on all roads.

The assistance systems help to make the driver's life easier by:

- providing the driver with information
- prompting the driver with suggestions
- automatically intervening in the driving process

This information bulletin contains an overview of all the assistance systems used in the G12:

- Camera-based collision warning
- Collision warning with city braking function
- Pedestrian warning with city braking function
- Road sign recognition
- Proactive Active Driving Assistant
- Lane departure warning
- Blind spot detection
- Side collision warning
- Alertness assistant
- Night vision
- Camera systems
- cross-traffic warning
- Park Distance Control
- Parking Maneuver Assistant
- Speed control
- Speed limit warning
- Steering and lane control assistant including traffic jam assistant
- Active Lane keeping assistant with active side collision protection

Identifying road users driving ahead as well as detecting objects and lane edges are among the most important prerequisites for the assistance systems. This applies not only for the far range but also the close range.

The optional functions available for the G12 are implemented either as camera-based systems with a shared camera and integrated control unit, or as sensor systems such as ultrasonic or radar sensors. Evaluation signals provided by various control units (for example, from the Advanced Crash Safety Module (ACSM)) are also taken into consideration.

For more information on the operating concept of the assistance systems, please refer to the Owner's Handbook.

G12 Driver Assistance Systems

2. G12 Bus Overview

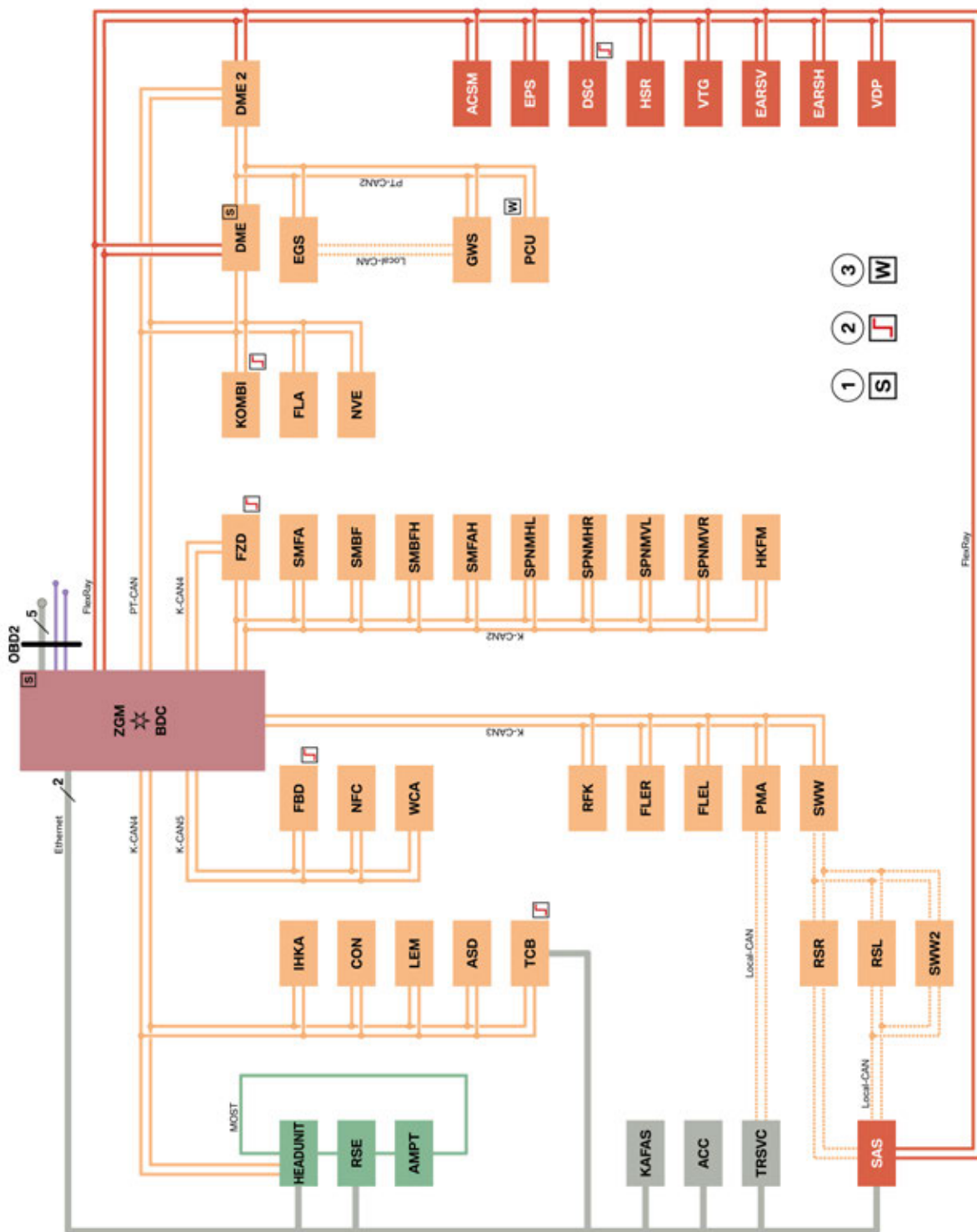

TE14-1183_2

G12 bus overview

G12 Driver Assistance Systems

2. G12 Bus Overview

Index	Explanation
ACC	Active cruise control
ACSM	Advanced Crash Safety Module
AMPT	Top Hi-Fi amplifier
ASD	Active Sound Design
BDC	Body Domain Controller
CON	Controller
DME	Digital Motor Electronics
DME2	Digital Engine Electronics 2
DSC	Dynamic Stability Control
EARSH	Electric active roll stabilization rear
EARSV	Electric active roll stabilization front
EGS	Electronic transmission control
EPS	Electromechanical Power Steering
FLA	High-beam assistant
FLER	Frontal Light Electronics Right
FLEL	Frontal Light Electronics Left
FZD	Roof function centre
GWS	Gear selector
HEADUNIT	Head unit
HKFM	Tailgate function module
HSR	Rear axle slip angle control
IHKA	Integrated automatic heating / air conditioning
KAFAS	Camera-based driver support systems
KOMBI	Instrument panel
LEM	Light effect manager
NFC	Near Field Communication
NVE	Night Vision Electronics
PCU	Power Control Unit
PMA	Parking Maneuver Assistant
RFK	Reversing camera
RSE	Rear Seat Entertainment
RSL	Radar sensor, left (avoidance assistant)
RSR	Radar sensor, right (avoidance assistant)
SAS	Optional equipment system
SMBF	Seat module, passenger

G12 Driver Assistance Systems

2. G12 Bus Overview

Index	Explanation
SMBFH	Seat module, passenger, rear
SMFA	Seat module, driver
SMFAH	Seat module, driver, rear
SPNMHL	Seat pneumatics module back left
SPNMHR	Seat pneumatics module back right
SPNMVL	Seat pneumatics module front left
SPNMVR	Seat pneumatics module front right
SWW	Blind spot detection (primary)
SWW2	Blind spot detection (secondary)
TCB	Telematic Communication Box
TRSVC	Top rear side view camera
VDP	Vertical dynamic platform
VTG	Transfer box
WCA	Wireless charging oddments tray
ZGM	Central gateway module
1	Start-up node control units for starting and synchronizing the FlexRay bus system
2	Control units with wake-up authorization
3	Control units also connected at terminal 15WUP

G12 Driver Assistance Systems

3. KAFAS

As the requirements placed on the KAFAS camera have increased in the G12, the existing monochrome camera has been replaced by a stereo camera.



KAFAS stereo camera

The KAFAS stereo camera is composed of two high-resolution CMOS monochrome cameras, which are installed in a housing with approximately 20 cm between them. The KAFAS stereo camera housing now also serves as an equipment holder for the KAFAS control unit, which has more powerful processors.

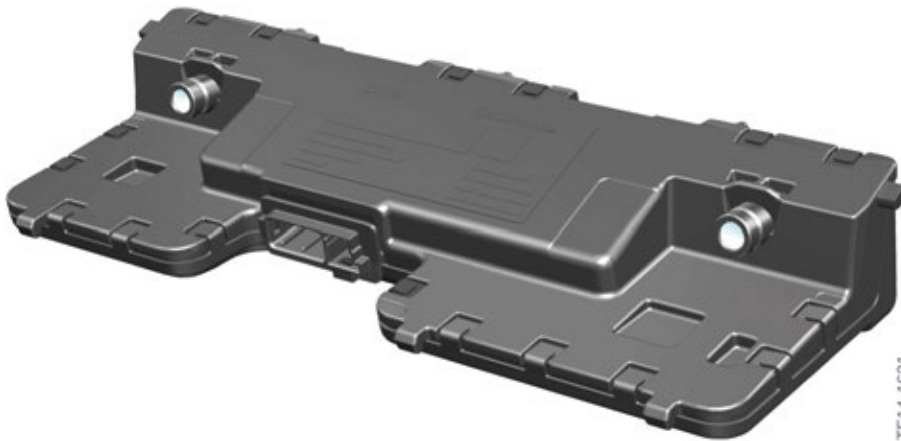

KAFAS stereo camera

CMOS cameras are characterized by their low power consumption, compact size and very high frame rate.

CMOS = Complementary Metal Oxide Semiconductor

The KAFAS stereo camera is calibrated within a distance of approximately 2 km during driving.

The KAFAS stereo camera is the key element of the following systems:

G12 Driver Assistance Systems

3. KAFAS

- Tailgate warning
- Collision warning with city braking function
- Pedestrian warning with city braking function
- Lane departure warning
- Road sign recognition.

The KAFAS stereo camera plays a supporting role in the following systems:

- Active Cruise Control with Stop&Go (ACC)
- Steering and lane control assistant including traffic jam assistant
- Active lane keeping assistant with active side collision protection

3.1. Detection range

Due to differences in perspective between the left and right optical path of the camera, the stereo camera is able to measure the distance to an object and now also its height above road level.

While the monochrome camera merely estimates distances, the stereo camera can determine the distance to an object fairly accurately – to within approximately 20 to 30 cm – from approximately 40 m away.



KAFAS stereo camera detection range

G12 Driver Assistance Systems

3. KAFAS

In principle, the evaluation electronics in the KAFAS stereo camera use the same effect as is used in a human to create spatial vision. This is known as the parallax shift between two images.

The KAFAS stereo camera not only enables the position of an object to be determined, but also its movement and direction of movement. For every pixel of a detected object, the direction of movement on the horizontal, vertical and longitudinal axis can be determined.

The KAFAS stereo camera has a detection range of up to approximately 40 m ahead of the vehicle and up to approximately 5 m in front of the vehicle on the right and left. The overall detection range of the KAFAS stereo camera is approximately 500 m.

3.2. Person recognition

The KAFAS stereo camera captures the scene in front of the vehicle and detects entire rear views of moving and stationary vehicles in the field of view using image processing. The KAFAS stereo camera also ensures that driving lane information, vehicle positions and movements are determined at the same time.

With the aid of the image data from the KAFAS stereo camera, objects can be clearly identified as vehicles and their transverse movements as lane changes. The KAFAS stereo camera also detects people and cyclists.



Example of pedestrian recognition by the KAFAS stereo camera: pedestrian approaching from the side steps into the road and is partially hidden

The two separate optical paths are also beneficial in challenging conditions, for example difficult lighting conditions, where there is low contrast between the image and background or when several objects are closely lined up one after the other.

Thanks to the redundant image detection of the stereo camera, it is now possible to reliably detect obstacles and determine their size from a single image.

G12 Driver Assistance Systems

3. KAFAS

3.3. Road sign recognition

The KAFAS stereo camera is also responsible for detecting top speed limitation road signs. The detection of no overtaking/overtaking permitted signs or markings is also implemented in the G12.

3.4. Lane detection

The KAFAS stereo camera installed in the mirror base of the interior mirror on the windshield monitors the area in front of the vehicle.

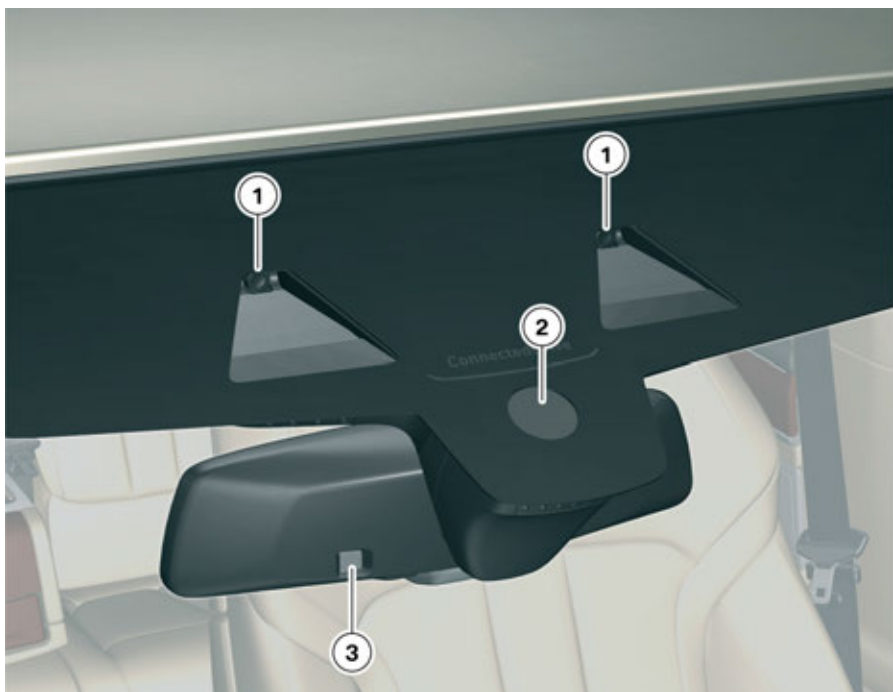

KAFAS stereo camera

Index	Explanation
1	KAFAS stereo camera
2	Rain-light-solar-condensation sensor
3	Photosensor for electrochromic interior mirror

The KAFAS stereo camera records the roadway up to approximately 40 m ahead of the vehicle and up to approximately 5 m to the right and left of the vehicle. The image data is then evaluated by the KAFAS control unit integrated in the KAFAS stereo camera. Using image processing, the control unit searches the images recorded by the KAFAS stereo camera for lane and road markings.

The appearance of the road markings can vary considerably in the image depending on the country, type of road or the current ambient conditions. The system can detect a wide range of road markings and types of markings. For a lane marking to be evaluated, the KAFAS stereo camera and the KAFAS control unit must first be able to clearly identify it. A lane must also have an average width greater than 2.5 m for it to be evaluated.

G12 Driver Assistance Systems

3. KAFAS

3.5. Detection of the road condition

The KAFAS stereo camera in the G12 also detects the road condition.

In vehicles with the Executive Drive Pro optional equipment (OE 2VS), the data collected is used to adapt the chassis and suspension setting to the road condition by changing various setting parameters in the Dynamic Drive (ARS) and Electronic Damper Control (EDC) and tailoring the interaction with the two-axle air suspension.

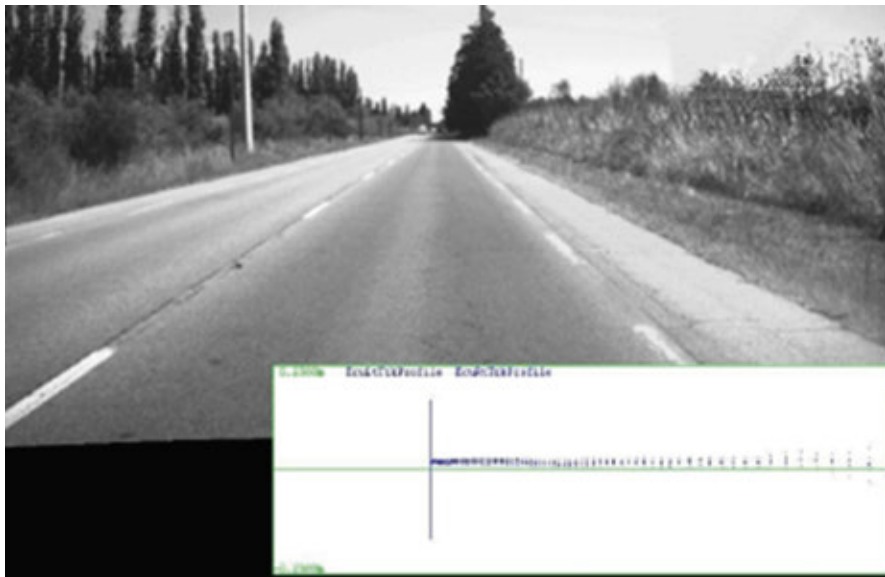

Detection of road bumps with the help of the stereo camera

Objects can now be dealt with actively instead of reactively, and therefore more easily, at speeds of approximately 15 to 100 km/h.

The structure of the vehicle moves less vertically, as the vehicle drives in harmony with the road. Bumps are less noticeable for the driver.

3.6. Functional limitations

The function of the KAFAS stereo camera and thus the function of the corresponding assistance systems may be impaired due to the physical limits of the optical systems, for example in the following situations:

- Heavy fog, rain, spray or snow
- Strong light in the camera lens
- If the field of view of the KAFAS stereo camera or the windscreen is dirty
- On tight bends
- If boundary lines are missing, worn, poorly visible, converging or diverging, or not clearly recognizable, as may be the case when roadworks are being carried out
- If boundary lines are covered by snow, ice, dirt or water
- If boundary lines are covered by objects

G12 Driver Assistance Systems

3. KAFAS

- If driving at close proximity to a vehicle driving ahead
- If the windscreen in front of the interior mirror is misted over, soiled or covered by stickers, e.g. tax discs, etc.
- Up to 10 seconds after driving readiness is activated via the start/stop button
- During the calibration process for the KAFAS stereo camera immediately after vehicle delivery or a camera change



Example of limits of the KAFAS stereo camera



Due to functional limitations and system restrictions it may transpire that warnings and orders are not issued, are issued too late or are unwarranted. Therefore, be attentive in order to be able to actively intervene at any time. Otherwise, there is a risk of an accident.

G12 Driver Assistance Systems

4. Optional Equipment System

The familiar optional equipment system (SAS) control unit is also used in the G12 and provides a range of driver assistance functions.

Possible functions:

- Tailgate warning
- Collision warning with city braking function
- Pedestrian warning with city braking function
- Dynamic Brake Control
- Distance information
- Dynamic Cruise Control
- Active speed control with Stop&Go function
- Lane & traffic jam assistant
- Speed limit
- Blind spot detection
- Lane departure warning
- Cross-traffic warning
- Parking Maneuver Assistant
- Proactive Active Driving Assistant

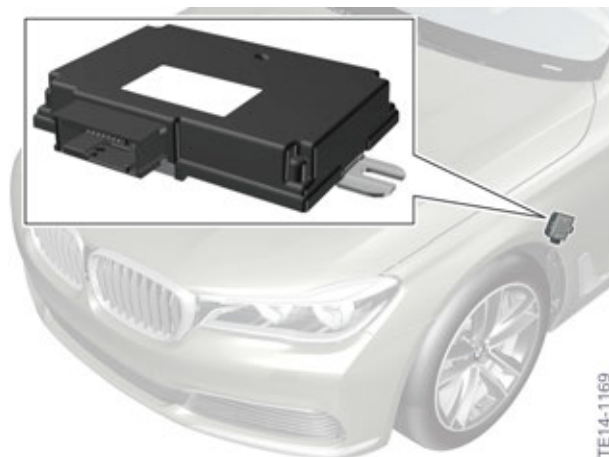

G12 optional equipment system (SAS) control unit

TE14-1169

G12 Driver Assistance Systems

5. Overview Of Sensors

The graphic below provides an overview of the main sensors used in the G12 for the assistance systems and shows their installation locations.

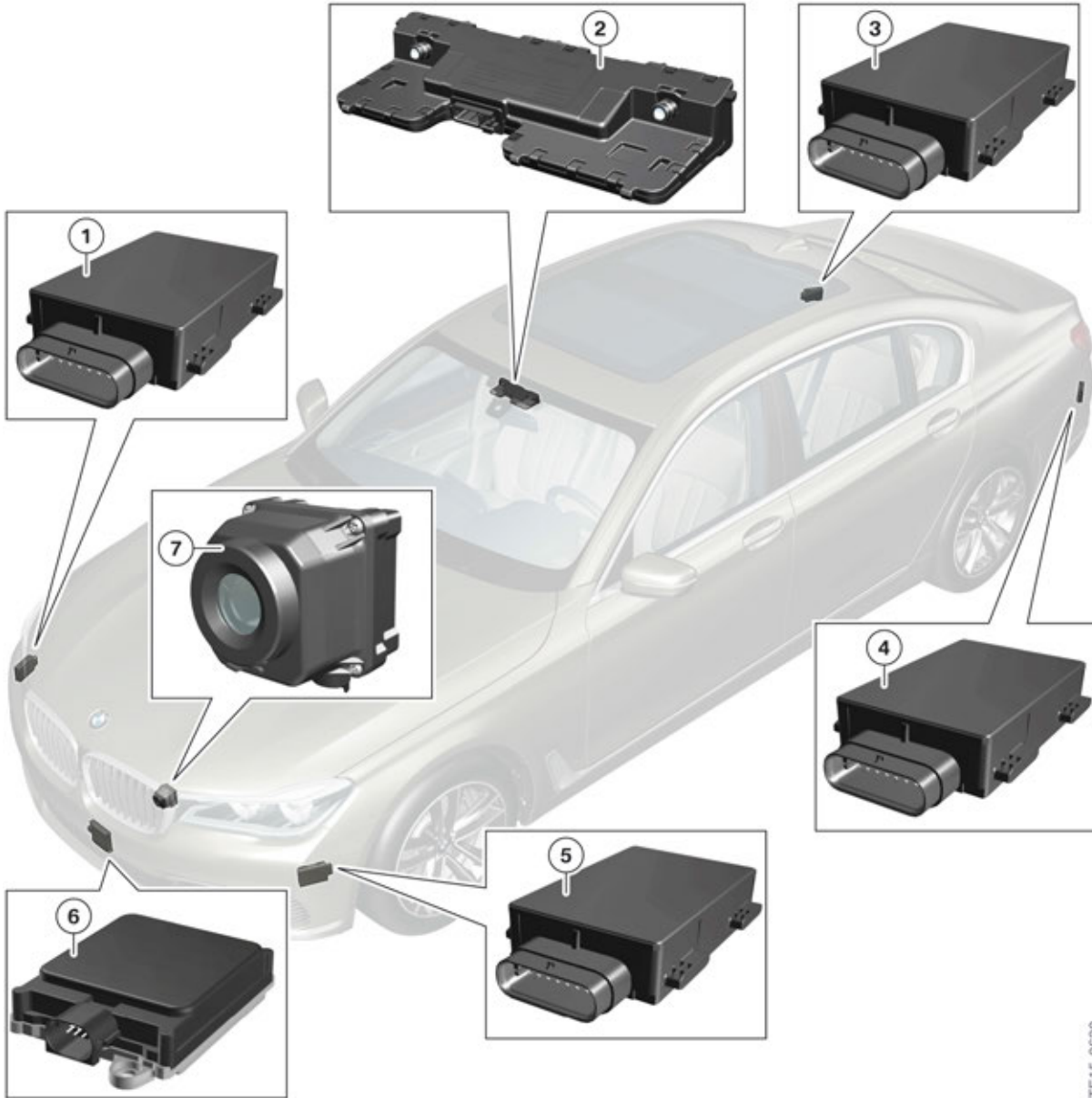

G12 overview of sensors

TE15-0620

G12 Driver Assistance Systems

5. Overview Of Sensors

Index	Explanation
1	Control unit for radar sensor, right (RSR)
2	KAFAS stereo camera
3	Blind spot detection, right (primary)
4	Blind spot detection, left (secondary)
5	Control unit for radar sensor, left (RSL)
6	Active Cruise Control (ACC) (FRR)
7	Night Vision camera

G12 Driver Assistance Systems

6. Intelligent Safety

Due to the ever increasing amount of traffic on our roads, assistance systems in vehicles continue to gain in importance. They assist the driver on highways, single-lane roads and in urban environments.

Urban traffic is just one area that presents an ever increasing number of challenges. Car drivers must be constantly aware of cyclists and pedestrians. Systems such as the pedestrian warning with city brake activation are helpful in this respect. Night Vision can assist the driver when driving on single-lane roads with adjacent woodland (deer crossings, etc.). The lane departure and Blind spot detection as well as the side collision warning provide even more safety in traffic. Accidents can be avoided through automatic brake interventions, active steering interventions or a combination of both.

Depending on the vehicle equipment, Intelligent Safety consists of one or several systems, which can help to avoid a potential collision. The following systems are offered in the G12:

- Tailgate warning with braking function
- Pedestrian warning with city braking function
- Night Vision with person and animal recognition
- Lane departure warning
- Blind spot detection
- Side collision warning

The Intelligent Safety button enables the assistance systems to be operated centrally. This means the systems can be switched on or off using a button and the submenu can be called up to personalize the settings.



G12 Intelligent Safety button

Index	Explanation
1	Intelligent Safety button

G12 Driver Assistance Systems

6. Intelligent Safety

Press button

- The "Intelligent Safety" menu is displayed on the central information display (CID). Settings can be made using the controller. The individual settings are stored for the respective ID transmitter used.

Press and release button

- When all Intelligent Safety systems are switched on:
Intelligent Safety systems are switched off individually depending on the individual setting.
- When all Intelligent Safety systems are not switched on:
All Intelligent Safety systems are switched on.

Press button for an extended period

- All Intelligent Safety systems are switched off.



G12 status indicator light (Intelligent Safety button)

Index	Explanation
A	All Intelligent Safety systems are switched on
B	Some Intelligent Safety systems are switched off or sub-function settings have been changed
C	All Intelligent Safety systems are switched off

The Intelligent Safety systems are automatically active after each engine start via the START-STOP button.

G12 Driver Assistance Systems

6. Intelligent Safety

6.1. Overview of the configuration menu

The system is operated by pressing the Intelligent Safety button and using a menu to configure the Intelligent Safety systems on the Central Information Display (CID).



G12 Intelligent Safety configuration menu overview

G12 Driver Assistance Systems

6. Intelligent Safety

Index	Explanation
1	"Intelligent Safety" configuration menu
2	"ALL ON" selection
3	"INDIVIDUAL" selection
4	"Configure INDIVIDUAL"
5	"ALL OFF" selection
6	Note for the driver: in this example not all of the Intelligent Safety systems could be activated.
7	Note for the driver: the colored circle shows the driver the activation status of the Intelligent Safety systems. The color of the circle changes always matches the color of the Intelligent Safety button indicator light.

"ALL ON"

- All Intelligent Safety systems are switched on. The basic settings are activated for the sub-functions, for example the warning time setting. The Intelligent Safety button lights up green.

"INDIVIDUAL"

- The Intelligent Safety systems are switched on in accordance with the individual settings. Depending on the vehicle equipment, the Intelligent Safety systems can be configured individually. The individual settings are activated and stored for the respective ID transmitter used.



G12 Intelligent Safety ("Configure INDIVIDUAL" selection)

Index	Explanation
1	"Intelligent Safety"
2	"Configure INDIVIDUAL"

G12 Driver Assistance Systems

6. Intelligent Safety



G12 Intelligent Safety "INDIVIDUAL" configuration menu (settings options)

Index	Explanation
1	"Configure INDIVIDUAL "
2	"Pedestrian warning active"
3	"Dynamic Marker Light"
4	"Collision warning" (selected setting: Early)
5	"Lane departure warning" (selected setting: Always)
6	"Steering intervention"
7	"Blind spot detection" (selected setting: Medium)

As soon as a setting is changed in the menu, all the settings the driver has previously configured are activated. The Intelligent Safety button lights up orange.

"ALL OFF"

- All Intelligent Safety systems are switched off. The Intelligent Safety button does not light up.

G12 Driver Assistance Systems

7. Collision Warning

The camera-based collision warning is part of the Active Driving Assistant optional equipment (OE 5AS) in the G12 and is implemented using the KAFAS stereo camera.

The collision warning in the new BMW 7 Series contains the familiar "Collision warning with city brake activation" and the "Pedestrian warning with city brake activation" functions.

In vehicles with the Active Cruise Control with Stop&Go function optional equipment (OE ZN7), the cruise control radar sensor is also used to control the collision warning.

Vehicles with the Active Driving Assistant Plus optional equipment (OE 5AT) have the Active Cruise Control with Stop&Go function optional equipment (OE ZN7) integrated as standard.

If the vehicle is not equipped with the Active Driving Assistant (OE 5AS) or Active Driving Assistant Plus (OE 5AT) optional equipment, but does have the Active Cruise Control with Stop&Go function optional equipment (OE ZN7), the customer also receives a collision warning. However, in this case the pedestrian warning is not included.

The system warns the driver in situations where a collision is imminent. The early warning, a visual signal, is issued first to draw the driver's attention to the situation. If the situation becomes more critical, an acute early warning in the form of a visual and acoustic signal is issued. The nature of the warning is such that the driver can still prevent a collision providing he acts quickly.

7.1. Functional principle

The KAFAS stereo camera captures the scene in front of the vehicle and detects entire rear views of moving and stationary vehicles in the field of view using image processing.

In vehicles with the Active Cruise Control with Stop&Go function optional equipment (OE ZN7), in addition to the KAFAS stereo camera image data, information from the radar sensor is also evaluated.

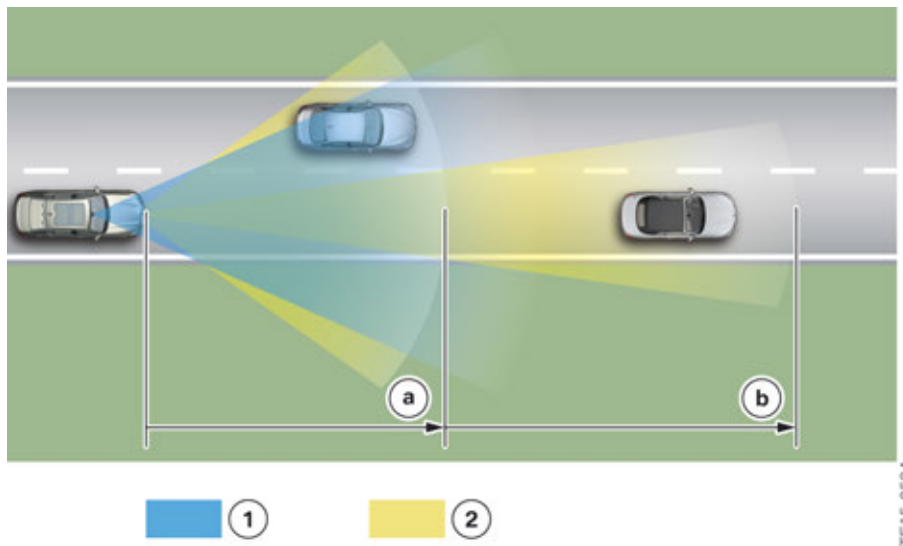

G12 schematic diagram of the monitoring ranges

G12 Driver Assistance Systems

7. Collision Warning

Index	Explanation
a	Close range
b	Long distance
1	KAFAS stereo camera detection range
2	Detection range of the radar sensor

The corresponding warning stages "early warning" and "acute warning" are output in critical situations on the basis of the calculated positions, distances and relative speeds of other vehicles. For the early warning the brakes of the vehicle are prepared for emergency braking and the activation thresholds of the Dynamic Brake Control are reduced. If the driver makes the conscious decision to drive up close to the vehicle ahead, warnings which may otherwise be distracting can be prevented by reducing the sensitivity of the system.

7.1.1. Collision warning with city braking function

The collision warning with city brake activation (City Collision Mitigation option OE ZN3) adds a brake activation function to the camera-based collision warning from a speed of roughly 5 km/h up to a maximum speed of 80 km/h. If there is still no response from the driver in this speed range after an acute warning is issued, the vehicle is decelerated at a maximum rate of 4 m/s².

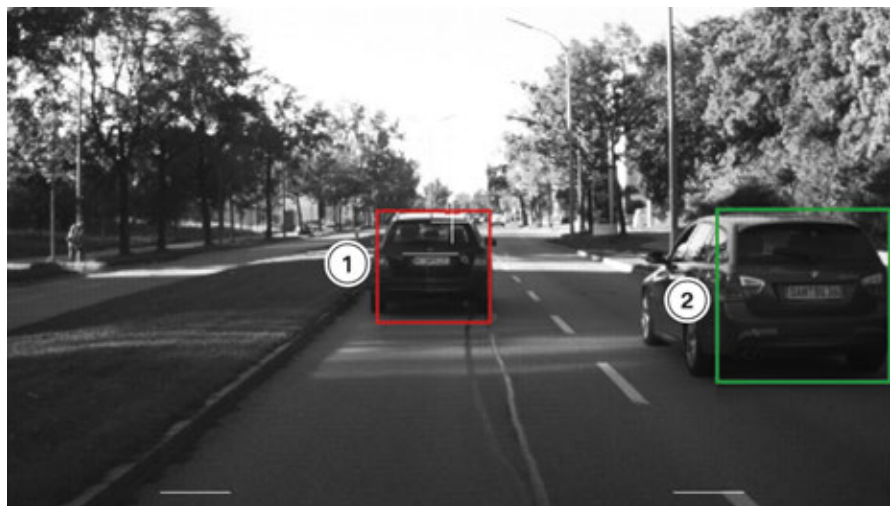

Example of vehicle identification by KAFAS camera

Index	Explanation
1	Vehicle in same lane
2	Vehicle in different lane

The duration of the brake intervention is limited to approximately 1.5 seconds. Additional dangers for the traffic behind are therefore avoided.

G12 Driver Assistance Systems

7. Collision Warning

7.1.2. Pedestrian warning with city braking function

The pedestrian warning with city braking function (Daytime pedestrian detection OE ZN2) is designed to prevent possible collisions with pedestrians in urban areas or reduce the effects of an accident. The system warns of a possible collision with pedestrians from a speed of approximately 10 km/h up to a maximum speed of 60 km/h and assists the driver with a brake intervention shortly before a collision.

The KAFAS stereo camera captures the scene in front of the vehicle and detects pedestrians in the field of view using image processing.

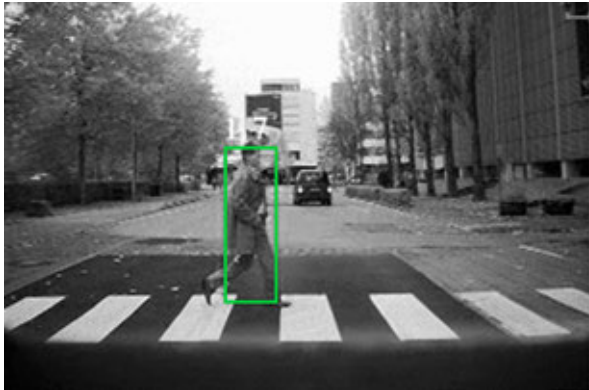

Example of person recognition by KAFAS camera

Based on the calculated positions, distances and the movement of the detected pedestrians, an acute warning is issued in critical situations. An early warning is not available for the pedestrian warning with city braking function (OE ZN2).

With an acute warning the vehicle is decelerated by roughly 4 m/s². The duration of the brake intervention is limited to approximately 1.5 seconds. Additional dangers for the traffic behind are therefore avoided.



7.2. Warning and braking function

The operating principle of the collision warning is based on a detection and warning algorithm. Machine vision detects pedestrians and vehicles in the detection range of the camera. If there is a risk of a collision, a warning symbol is shown in the instrument cluster (KOMBI), or in the Head-Up Display for vehicles with the Head-Up Display standard equipment (OE 610). The warning function is divided into two stages. The next probable movement of an object is determined based on the current movement of the detected object and, taking into account the movement of the object, a collision risk is identified. If a situation is evaluated as critical by the warning algorithm, a warning is issued and braking is introduced based on a multistage warning concept. The warnings and brake interventions differ for pedestrians and vehicles.

G12 Driver Assistance Systems

7. Collision Warning

7.2.1. Displays

Symbol	Explanation
	Early warning: <ul style="list-style-type: none">• Vehicle symbol lights up red• Increase distance and brake if necessary
	Acute warning: <ul style="list-style-type: none">• Vehicle symbol flashes red and a signal sounds• Request for intervention by braking and evasive action, if required
	Acute warning: <ul style="list-style-type: none">• Person symbol flashes red and a signal sounds• Request for intervention by braking and evasive action, if required

7.2.2. Early warning

Occasions when an early warning is issued include when there is a collision risk because the vehicle driving ahead is being driven at a much slower speed and/or if the distance to a driven or stationary vehicle ahead is extremely short.

An early warning is indicated by a vehicle symbol which lights up red in the instrument cluster (KOMBI) or Head-Up Display. The early warning is only issued for vehicles and not for pedestrians.

The point at which the early warning is issued can be configured in the "Intelligent Safety systems" menu on the central information display (CID).



The collision warning is dependent on the vehicle's own driving speed. The distance measured for the collision warning is significantly lower than the legally required minimum distance. It is therefore the responsibility of the driver to adhere to the legal minimum distance.

7.2.3. Acute warning

The acute warning is issued by the system as late as possible and only if there is an imminent danger of a collision when the vehicle is approaching the vehicle driving ahead at a relatively high differential speed or if there is an imminent danger of a collision with a pedestrian. The time of the acute warning is measured so that a collision can only be avoided by immediate emergency braking or by swerving. The acute warning therefore cannot be deliberately brought about or monitored by the driver. The acute warning is issued for vehicles and pedestrians.

G12 Driver Assistance Systems

7. Collision Warning

If the vehicle is approaching the vehicle driving ahead or a pedestrian at a very low speed, an acute warning is not issued even when the distance is very small. This intentional driving situation only triggers the early warning. This way there are fewer meaningless and annoying acute warnings issued by the system.

The acute warning cannot be deactivated separately. The timing of the acute warning also cannot be adjusted. If the acute warning is not to be issued, the "collision warning" front protective function must be deactivated.

If an acute warning is issued, this is indicated to the driver by a red flashing vehicle symbol or a red flashing person symbol in the instrument cluster (KOMBI) or Head-Up Display. In addition, an acoustic warning signal is sounded.

The acute warning for pedestrians is issued within a speed range of approximately 10 km/h to 60 km/h. The acute warning for vehicles is issued at speeds above approximately 5 km/h.

When the acute warning is issued, the brake system is also preconditioned in order to achieve quicker and sharper deceleration. With these measures the driver also receives specific support at the same time as the warning in order to be able to respond effectively.



The acute warning does not relieve the driver of his responsibility to adapt the speed and driving style to the traffic conditions.

7.2.4. Brake intervention

With the camera based, collision warning w/ city collision mitigation (OE ZN3 included with OE 5AS); If the driver no longer has the option to avoid the accident with his own response, automatic brake intervention is effected as a last step. The brake intervention is effected at a brake force of about 4 m/s² (camera based) and can have the effect of avoiding a collision up to a differential speed of about 18 km/h. At higher differential speeds the impact speed is reduced by a smaller amount. Just like the driver can support the effect of the system, he also has the option of overriding and thus cancelling the automatic panic braking at any time with a steering wheel movement (avoidance maneuver), by accelerating or with a sharp brake intervention.

With the camera and radar based, collision warning system (included with OE 5AT); If the driver no longer has the option to avoid the accident with his own response, automatic brake intervention is effected as a last step. The brake intervention is effected at a brake force of about 8 m/s² (camera/radar based) and can have the effect of avoiding a collision up to a differential speed (delta) of about 30 km/h.

Therefore, both systems can bring car to a stop, the difference is that you are more likely to see this happen in a 5AT car then a 5AS car. This is why 5AS is referred to as "city collision MITIGATION" because this is the more likely use case as opposed to "AVOIDANCE" with 5AT.

The brake intervention is effected for pedestrians in the speed range between 10 and 60 km/h and for vehicles in the speed range between 5 and 60 km/h.

For a brake intervention to be possible, the Dynamic Stability Control (DSC) must be switched on.

G12 Driver Assistance Systems

7. Collision Warning

Time plan for collision warning with city braking function (OE ZN3)

The time plan of the warnings and braking is demonstrated in the following graphic. If an avoidance measure by the driver is detected, there is no brake intervention.

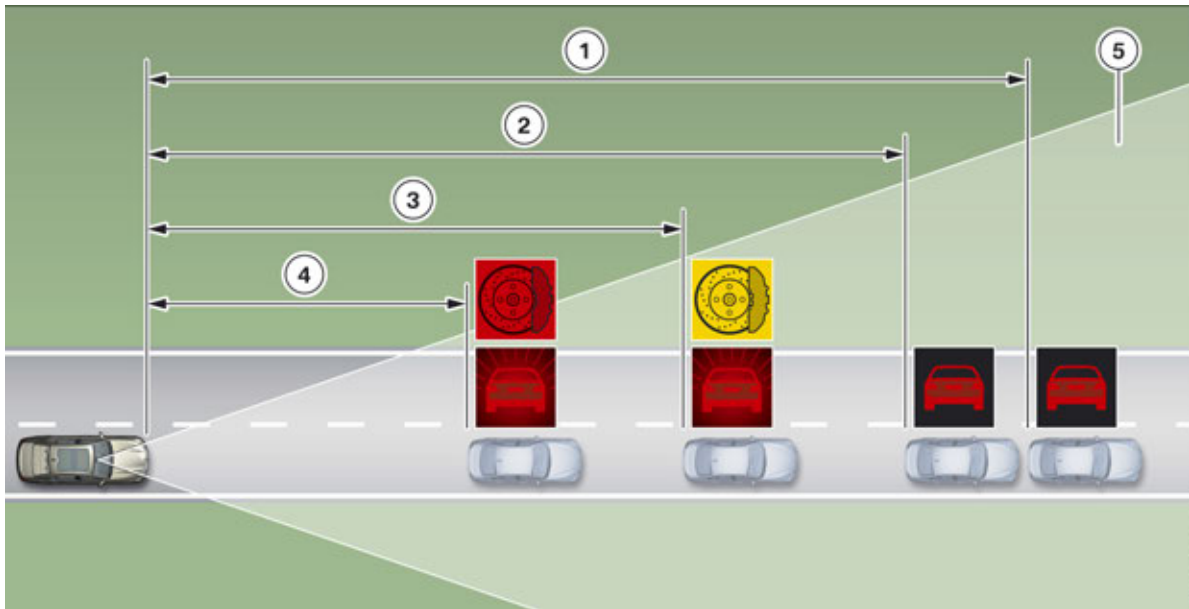

Time plan for the collision warning

Index	Explanation
1	Collision warning ("early")
2	Collision warning ("late")
3	Acute warning (acoustic warning signal, brake system is pre-filled and brake assistants are adapted)
4	Braking at 4 m/s ² is applied with the 5AS city brake activation (only between 5 and 60 km/h) and 8 m/s ² with the (5AT) camera/radar based system
5	KAFAS stereo camera detection range

G12 Driver Assistance Systems

7. Collision Warning

7.3. Operation

The collision warning and pedestrian warning are switched on and off via the Intelligent Safety button.



G12 Intelligent Safety button

Index	Explanation
1	Intelligent Safety button

The point at which the early collision warning is issued can be configured in the "Intelligent Safety systems" menu on the central information display (CID).

G12 Driver Assistance Systems

7. Collision Warning

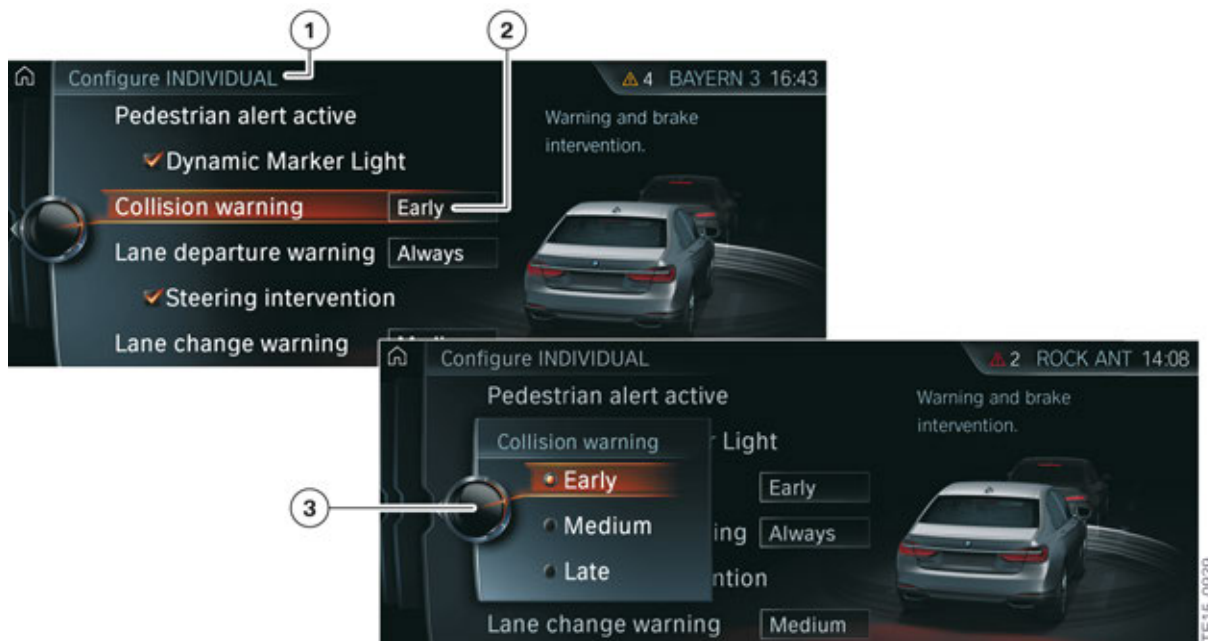

G12 Intelligent Safety view on the CID (collision warning with city brake activation)

Index	Explanation
1	"Configure INDIVIDUAL"
2	"Collision warning" (selected setting: Early)
3	"Collision warning" (settings options: Early, Medium, Late)

The acute warning cannot be deactivated separately. The timing of the acute warning also cannot be adjusted. If the acute warning is not to be issued, the "collision warning" front protective function must be deactivated. The collision warning can be switched off by holding down the Intelligent Safety button.

It is also not possible to configure or deactivate the pedestrian warning separately. The "collision warning" front protective function must be also deactivated by holding down the Intelligent Safety button in order to deactivate the pedestrian warning function.



G12 Intelligent Safety view on the CID (pedestrian warning with city brake activation)

G12 Driver Assistance Systems

7. Collision Warning

Index	Explanation
1	"Configure INDIVIDUAL "
2	"Pedestrian warning active"
3	Note for the driver: "Pedestrian warning cannot be configured."

7.4. Limits of the system

Range of detection



The collision warning has a limited capacity for detection.

As a result, incorrect or delayed warnings may occur. It is possible the following vehicles are not detected:

- A slow vehicle when driving off at high speed
 - Vehicles that suddenly swerve or decelerate rapidly
 - vehicles with an unusual rear view or with insufficiently visible rear lights
 - Partially concealed vehicles
 - Two-wheeled vehicles travelling ahead.
-

Functional limitations

The function of the KAFAS stereo camera and thus also the function of the corresponding assistance systems may be impaired in the following situations, for example:

- Heavy fog, rain, spray or snow
 - Insufficient light
 - Strong light in the camera lens
 - If the field of view of the KAFAS stereo camera or the windscreen is dirty
 - On sharp bends
 - With pedestrians up to approximately 80 cm in height
 - Up to 10 seconds after the engine start via the START-STOP button
 - During the calibration process for the KAFAS stereo camera immediately after vehicle delivery or a camera change
-



Due to functional limitations and system restrictions it may transpire that warnings and orders are not issued, are issued too late or are unwarranted. Therefore, be attentive in order to be able to actively intervene at any time. Otherwise, there is a risk of an accident.

G12 Driver Assistance Systems

8. Lane Departure Warning

The lane departure warning is an element of the optional equipment Active Driving Assistant (SA 5AS) and the optional equipment Active Driving Assistant Plus (SA 5AT).

The lane departure warning detects lane markings from a speed of approximately 70 km/h and warns the driver against unintentionally leaving the lane.

The information required about usable roadway and lane markings is provided by the KAFAS stereo camera. Based on the calculated positions, lane edges and curves in relation to the relative position of the driver's vehicle, a corresponding warning is issued.

If the driver crosses the lane marking unintentionally (without using the turn indicator) or leaves the road boundary, he is warned by the steering wheel vibrating gently and has the opportunity to react accordingly. The vibration in the steering wheel can be compared to the vibration effect when driving over a profiled road marking.

In the settings menu the driver can set the desired strength of the vibration warning on the steering wheel via the iDrive.



G12 steering wheel vibration settings menu on CID

Index	Explanation
1	Steering wheel vibration menu
2	Additional note for the driver
3	"Strong"
4	"Medium"
5	"Light"

If the driver uses the turn indicator when moving across to another lane, the lane departure warning recognizes that this is an intentional lane change and a warning is not issued.

The lane departure warning can be configured individually in the Intelligent Safety system submenu.

G12 Driver Assistance Systems

8. Lane Departure Warning



G12 Intelligent Safety view on the CID (lane departure warning)

Index	Explanation
1	"Configure INDIVIDUAL"
2	"Lane departure warning" (selected setting: Always)
3	"Lane departure warning" (settings options: Always, Reduced, Off)

The individual settings applied by the driver are saved for the driver profile currently in use.

Displays in the instrument cluster (KOMBI)

Symbol	Explanation
	At least one lane boundary has been detected and warnings can be issued.

G12 Driver Assistance Systems

8. Lane Departure Warning

8.1. Active steering intervention

In vehicles with the side collision warning (included in Active Driving Assistant Plus optional equipment OE 5AT), the driver is assisted by another measure known as "active steering intervention".

If the driver does not react to the warning issued by the lane departure warning system and crosses the lane marking, he is assisted to stay in lane by a brief active steering intervention.

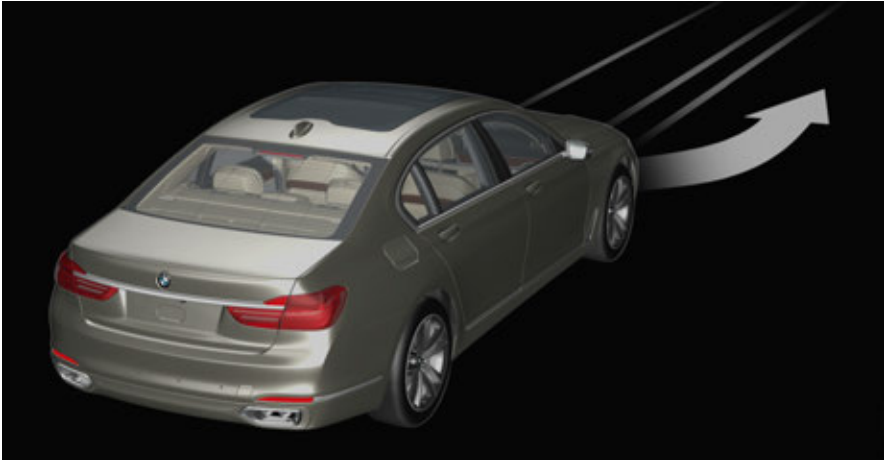

G12 active steering intervention

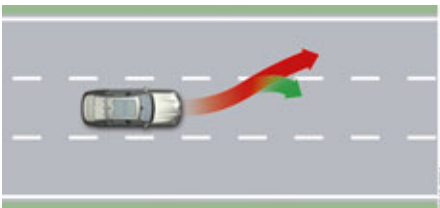

G12 lane departure warning (active steering intervention)

The active steering intervention can be felt on the steering wheel, but can be overridden by the driver at any time. If the driver does override the intervention, the active steering intervention is cancelled.

The "steering intervention" for the lane departure warning can be switched on and off in the iDrive menu in vehicles with the side collision warning by making the following selection via the controller:

- "My Vehicle"
- "Vehicle settings"
- "Intelligent Safety"
- "Steering intervention"

The configuration menu can be accessed quickly by pressing the Intelligent Safety button.

G12 Driver Assistance Systems

8. Lane Departure Warning



G12 Intelligent Safety view on the CID (lane departure warning with active steering intervention)

Index	Explanation
1	"Configure INDIVIDUAL "
2	"Steering intervention" (switching the steering intervention for lane departure warning on and off)

Steering interventions are not initiated when the trailer socket is in use, such as when a trailer is being towed or a bicycle carrier is mounted.

G12 Driver Assistance Systems

8. Lane Departure Warning

8.2. System wiring diagram

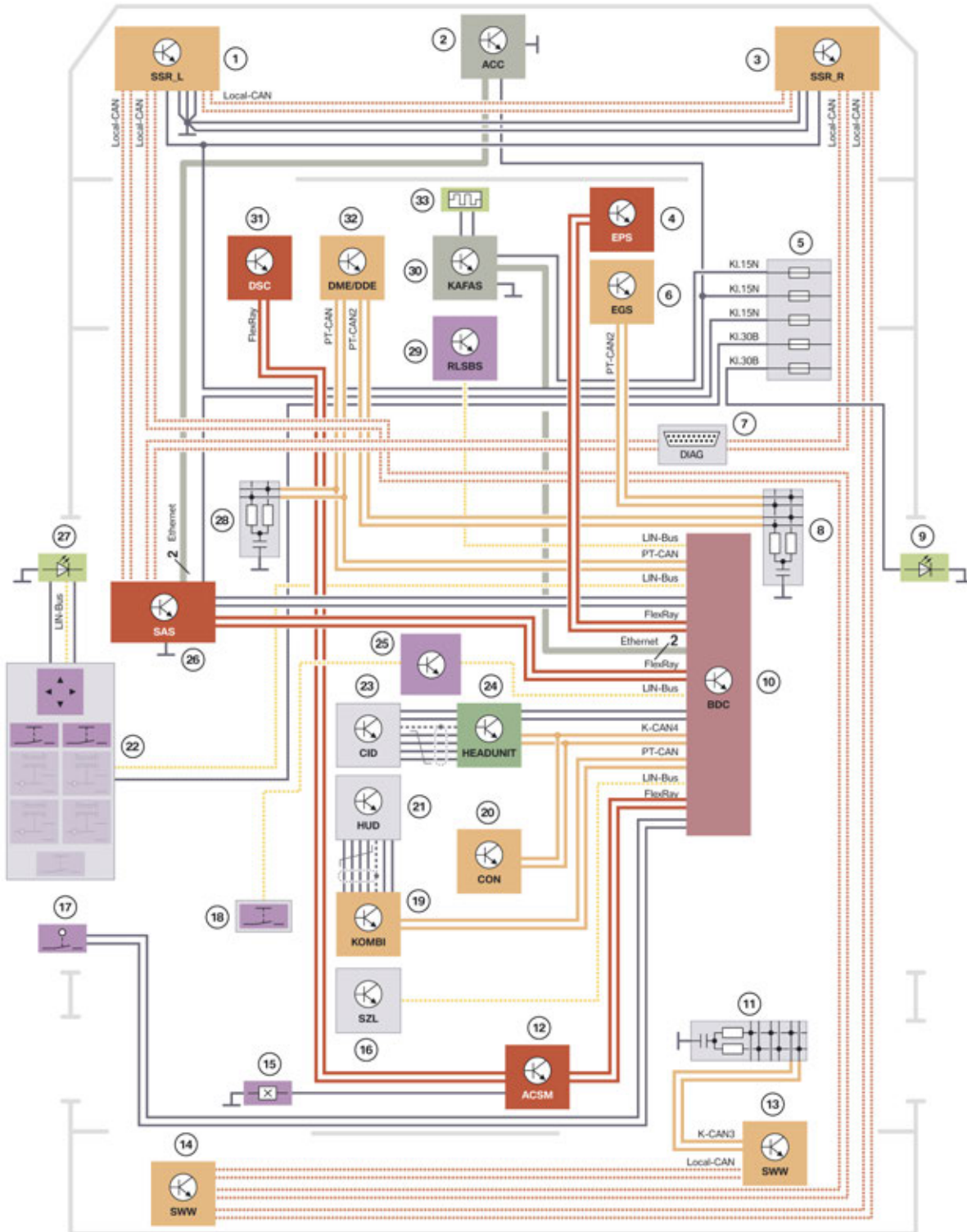

TE15-0521

G12 Active Driving Assistant Plus (OE 5AT)/lane departure warning system wiring diagram

G12 Driver Assistance Systems

8. Lane Departure Warning

Index	Explanation
1	Control units for radar sensor, left (RSL) (side radar sensor for the front left side collision warning)
2	Active Cruise Control (ACC)
3	Control units for radar sensor, right (RSR) (side radar sensor for the front right side collision warning)
4	Electronic Power Steering EPS
5	Fuse for power distribution box, front right
6	Electronic transmission control (EGS)
7	Diagnostic socket
8	CAN terminator
9	Signal unit (LED) in right mirror glass
10	Body Domain Controller (BDC)
11	CAN terminator
12	Advanced Crash Safety Module (ACSM)
13	Blind spot detection, right (primary)
14	Blind spot detection, left (secondary)
15	Seat belt buckle switch, driver
16	Steering column switch cluster (SZL)
17	Driver's door lock switch
18	Intelligent Safety button
19	Instrument panel (KOMBI)
20	Controller CON
21	Head-Up Display (HUD)
22	Switch block for driver's door
23	Central information display (CID)
24	Head Unit High 2 (HU-H2)
25	Audio control panel
26	Control unit for optional equipment system (SAS)
27	Signal unit (LED) in left mirror glass
28	CAN terminator
29	Rain-light-solar-condensation sensor (RLSBS)
30	KAFAS stereo camera
31	Dynamic Stability Control (DSC)
32	Digital Motor Electronics (DME)
33	KAFAS stereo camera heating

G12 Driver Assistance Systems

8. Lane Departure Warning

8.3. Deactivation criteria

The lane departure warning is available at a speed range from 70 to 210 km/h.

A warning is not issued in the following situations:

- When the driver uses the turn indicator
- In roadworks
- When the lane width is less than 2.60 m

The warning is cancelled in the following situations:

- Automatically after approximately 3 seconds
- As soon as the driver moves back into his own lane
- If the turn indicator is used
- When sharp braking or steering maneuvers are made and when the Dynamic Stability Control (DSC) intervenes.

8.4. Limits of the system

The function of the system may not be available or may only be available to a limited extent in the following situations:

- heavy fog, rain or snow
- at sharp bends or on narrow roadways
- if boundary lines are covered by snow, ice, dirt or water
- if boundary lines are covered by objects
- if boundary lines are missing, worn, poorly visible, converging or diverging, or not clearly recognizable, such as when driving through roadworks



The system does not replace the personal assessment of the road and the traffic situation. The lane departure warning is only intended to assist the driver. When active lane departure warnings are issued, the steering wheel should not be moved through any unnecessarily heavy-handed actions.

G12 Driver Assistance Systems

9. Blind Spot Detection

The Blind spot detection system can detect traffic situations that could pose a risk if the driver changes lane. These traffic situations include vehicles approaching quickly from behind or vehicles in the driver's blind spot.

The driver may find it difficult to judge these situations, especially when it is dark. The radar sensors detect vehicles in the blind spot and work effectively regardless of the lighting conditions. In addition, they are able to reliably detect such situations up to a distance of approximately 70 m away and irrespective of the weather conditions.

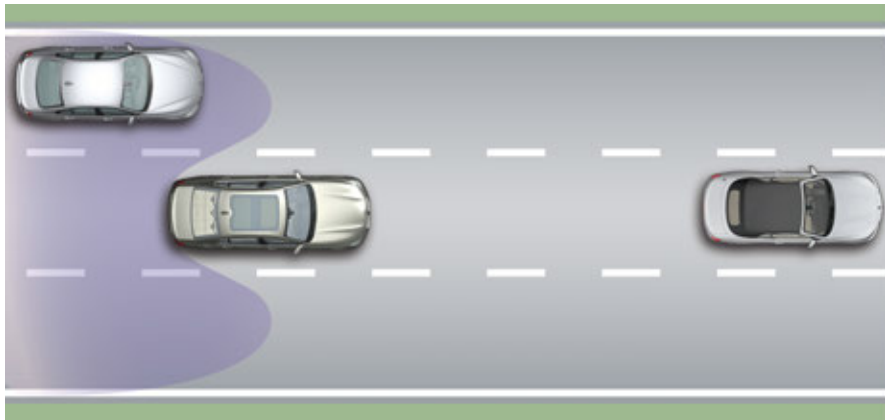

G12 vehicle detection using radar sensors (Blind spot detection)

When a vehicle is approaching quickly or moves into the blind spot of the driver's vehicle, the system assists the driver by correctly judging the situation. If the lane next to the driver's vehicle is occupied, the radar sensors detect the vehicles in the neighboring lane.

The control units (radar sensors) for the Blind spot detection (SWW) are located under the rear bumper.



G12 Blind spot detection (SWW) (radar sensors)

The control unit for the Blind spot detection (SWW) (primary) is installed on the right and the control unit for the Blind spot detection (SWW2) (secondary) is installed on the left.

When a vehicle is detected and the system is activated, the driver is informed of the situation by an unobtrusive indicator in the exterior mirror. By having this information before making a lane change maneuver, the driver can confidently prepare for the lane change and avoid critical situations from

G12 Driver Assistance Systems

9. Blind Spot Detection

the outset.

The Blind spot detection indicators are located in the exterior mirror glass.



G12 signal unit (LED) in mirror glass

If the driver intends to make a lane change in what the system detects to be a critical situation, and demonstrates this intention by using the turn indicator, the second, more severe "warning" is issued. The corresponding indicator in the exterior mirror flashes with high intensity and the steering wheel starts to vibrate. This warns the driver using the exact operating element that he must use to make the dangerous situation safe. To avoid a potential collision, the driver must steer the vehicle back into his own lane.

The Blind spot detection can be configured individually in the Intelligent Safety system submenu.

G12 Driver Assistance Systems

9. Blind Spot Detection

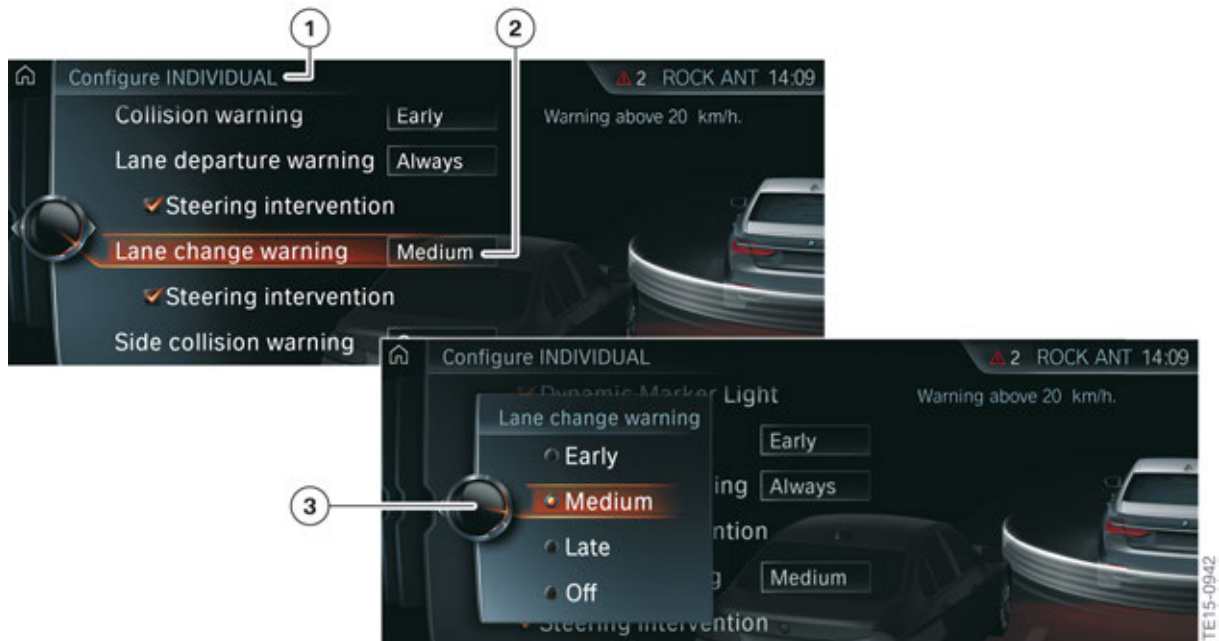

G12 Intelligent Safety view on the CID (Blind spot detection)

Index	Explanation
1	"Configure INDIVIDUAL"
2	"Blind spot detection" (selected setting: Medium)
3	"Blind spot detection" (settings options: Early, Medium, Late, Off)

9.1. Active steering intervention

Depending on the setting in the "Intelligent Safety" menu, a brief active steering intervention is initiated by the system that assists in moving the vehicle back into the original lane (vehicles with the side collision warning (included in the Active Driving Assistant Plus optional equipment OE 5AT)).

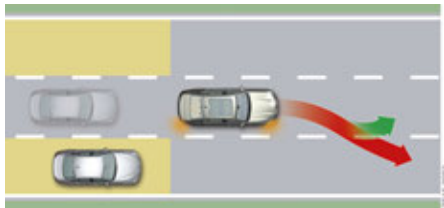

G12 Blind spot detection (active steering intervention)

The corresponding Blind spot detection indicator flashes in the exterior mirror at the same time.

The steering intervention is initiated within a speed range of between 70 km/h and 210 km/h.

The active steering intervention can be felt on the steering wheel, but can be overridden by the driver at any time. If the driver does override the intervention, the active steering intervention is cancelled.

G12 Driver Assistance Systems

9. Blind Spot Detection

The "steering intervention" for the Blind spot detection can be switched on and off in the iDrive menu in vehicles with the side collision warning by making the following selection via the controller:

- "My Vehicle"
- "Vehicle settings"
- "Intelligent Safety"
- "Steering intervention"

The configuration menu can be accessed quickly by pressing the Intelligent Safety button.

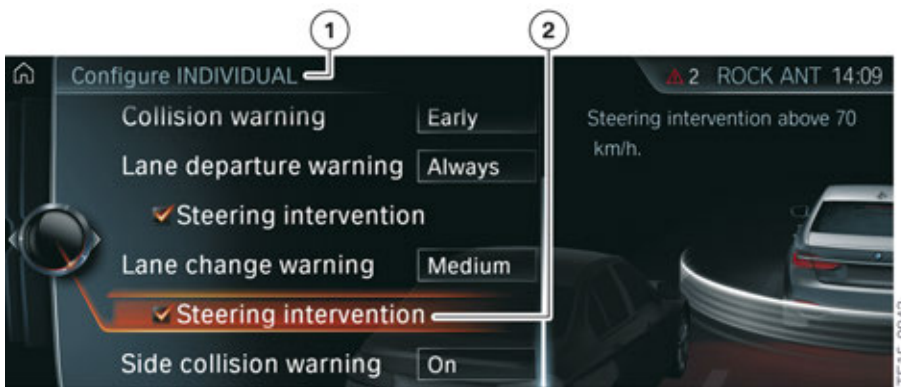

G12 Intelligent Safety view on the CID (Blind spot detection with active steering intervention)

Index	Explanation
1	"Configure INDIVIDUAL"
2	"Steering intervention" (switching the steering intervention for Blind spot detection on and off)

G12 Driver Assistance Systems

9. Blind Spot Detection

9.2. System wiring diagram

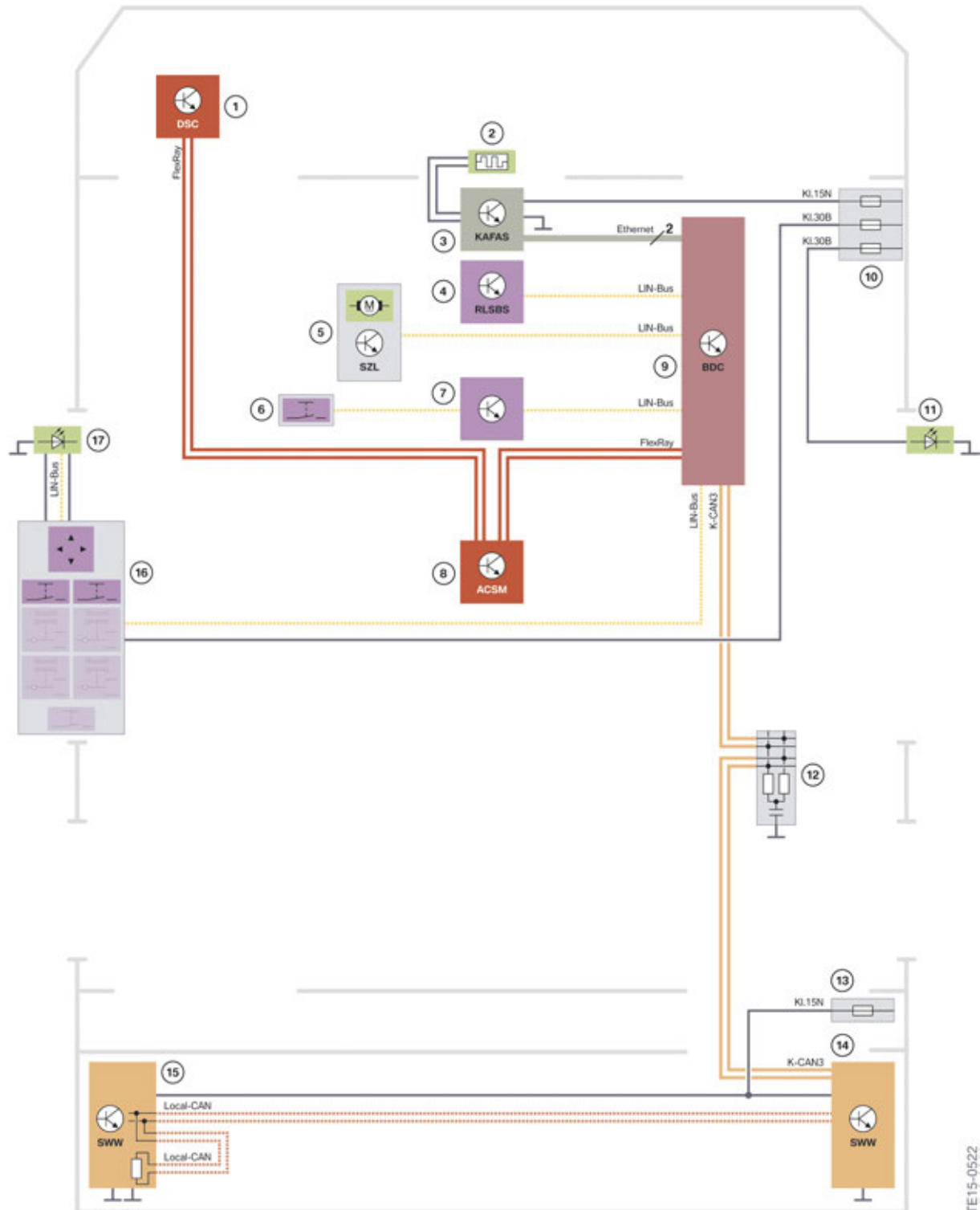

G12 Active Driving Assistant (OE 5AS)/Blind spot detection system wiring diagram

TE15-0522

G12 Driver Assistance Systems

9. Blind Spot Detection

Index	Explanation
1	Dynamic Stability Control (DSC)
2	KAFAS stereo camera heating
3	KAFAS stereo camera
4	Rain-light-solar-condensation sensor (RLSBS)
5	Steering column switch cluster (SZL)
6	Intelligent Safety button
7	Audio control panel
8	Advanced Crash Safety Module (ACSM)
9	Body Domain Controller (BDC)
10	Fuse for front right power distribution box
11	Signal unit (LED) in right mirror glass
12	CAN terminator
13	Fuse for rear right power distribution box
14	Blind spot detection, left (secondary)
15	Blind spot detection, right (primary)
16	Switch block for driver's door
17	Signal unit (LED) in left mirror glass

9.3. Limits of the system

The function of the system may not be available or may only be available to a limited extent in the following situations:

- heavy fog, rain or snow
- at sharp bends or on narrow roadways
- if the bumper is dirty, iced up or stickers are placed over it
- if the speed of the approaching vehicle is much higher than the driver's speed

G12 Driver Assistance Systems

10. Side Collision Warning

The side collision warning is part of the active lane keeping assistant with active side collision protection. The active lane keeping assistant with active side collision protection is part of the scope of supply of the Active Driving Assistant Plus optional equipment (OE 5AT). The side collision warning is not available separately.

The side collision warning assists the driver in avoiding a potential side collision.

If an object with which the vehicle could potentially collide, such as a vehicle or a crash barrier, is detected to the side of the driver's vehicle, the driver is assisted in avoiding the potential collision.

Four radar sensors monitor the area next to the vehicle and function regardless of the lighting conditions and largely irrespective of the weather conditions.

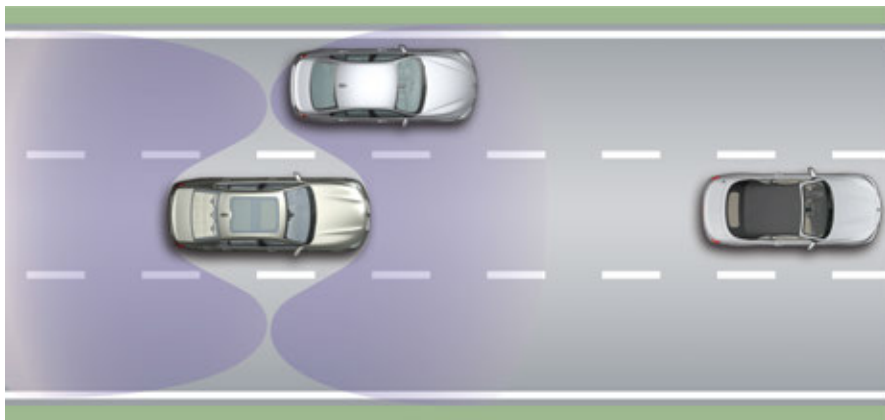

G12 vehicle detection using radar sensors (side collision warning)

If there is a risk of a collision, the corresponding indicator flashes (depending on which side the risk relates to, left or right) in the exterior mirror with high intensity and the steering wheel starts to vibrate.



G12 signal unit (LED) in mirror glass

An active steering intervention is then initiated, which assists the driver in moving his vehicle back

G12 Driver Assistance Systems

10. Side Collision Warning

to a safe area within his own lane.

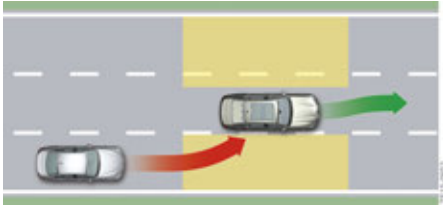

G12 side collision warning with active steering intervention in the event of a potential side collision

The steering intervention is initiated within a speed range of between 70 km/h and 210 km/h.

The active steering intervention can be felt on the steering wheel, but can be manually overridden by the driver at any time.

Radar sensors

The rear radar sensors are Blind spot detection (SWW) sensors.



G12 Blind spot detection (SWW) (radar sensors)

Two additional radar sensors are used for the front side collision warning.



G12 side collision warning (radar sensors)

G12 Driver Assistance Systems

10. Side Collision Warning

Functional prerequisites

A prerequisite for the activation of the side collision warning with steering intervention is that the lane markings must be detected by the KAFAS stereo camera.

If the lane markings are not detected or if the driver is driving within the speed range of 30 km/h to 70 km/h, only the reduced side collision warning is active. The warning functions in the form of the flashing indicator in the exterior mirror and the vibration of the steering wheel continue to be implemented.

With the reduced side collision warning there is no active lateral guidance of the vehicle. In this case the driver is only warned by a single steering wheel pulse on the opposite side of the wheel to the danger.

The side collision warning can be switched on and off in the iDrive menu by making the following selection via the controller:

- "My Vehicle"
- "Vehicle settings"
- "Intelligent Safety"
- "Side Collision Warning"

The configuration menu can be accessed quickly by pressing the Intelligent Safety button.



G12 Intelligent Safety view on the CID (side collision warning)

G12 Driver Assistance Systems

10. Side Collision Warning

Index	Explanation
1	"Configure INDIVIDUAL "
2	"Side collision warning"
3	"Side collision warning" (switching the side collision warning with steering intervention on and off)

It is not possible to switch off the steering intervention for the side collision warning separately.

The side collision warning automatically activates itself again after the vehicle moves off if the function was switched on at the time of the last engine shutdown.

10.1. Limits of the system

The function of the system may not be available or may only be available to a limited extent in the following situations:

- heavy fog, rain or snow
- at sharp bends or on narrow roadways
- if the bumper is dirty, iced up or labels are placed over it
- If driving at close proximity to a vehicle driving ahead
- if the speed of the approaching vehicle is much higher than the driver's speed

G12 Driver Assistance Systems

11. Road Sign Recognition

The Speed Limit Information optional equipment has been expanded to include the display of most legal signs (i.e. normal speed limit signs, school signs, construction signs) and will be referred to as road sign recognition from now on in this document. Current top speed limitations and no overtaking signs are detected by the road sign recognition system and displayed in the instrument cluster or the Head-Up Display in the form of road sign symbols.



Top speed limitation symbol shown in the instrument cluster

Index	Explanation
1	Road sign recognition (example: a detected top speed limitation is displayed)

The display of road signs is based on the evaluation of data from the navigation system and the evaluation of image data recorded by the KAFAS stereo camera.

The KAFAS stereo camera detects road signs at the edge of the road and also the variable displays of gantry signs. Road signs containing additional information, e.g. "In wet conditions", are also detected and synchronised with vehicle-internal data, e.g. the rain sensor, and displayed depending on the situation.

The system also takes the applicable time restrictions identified into account, e.g. "between 10.00 pm and 6.00 am". The current time of the on-board clock is used for this. The system takes the information stored in the navigation system into account and displays existing top speed limitations on sections of road without signage.

Road sign recognition (Speed Limit Information) is part of the Active Driving Assistant optional equipment (OE 5AS) in the G12.



The system does not relieve the driver of personal responsibility for correctly judging the visibility and traffic situation. The driver is solely responsible for the vehicle and the speed at which it is driven.

G12 Driver Assistance Systems

11. Road Sign Recognition

11.1. Operation

The road sign recognition can be switched on and off in the iDrive menu. by making the following selection via the controller:

- "My Vehicle"
- "System settings"
- "Displays"
- "Instrument Cluster"
- Apply desired settings.

11.2. Limits of the system

Road signs for top speed limitations that do not comply with the legal standard, particularly those without circular frames, are not always detected. The same also applies for traffic signs which are fully or partially covered by labels, dirt or vegetation. Long distances to the road sign, high driving speeds and poor weather conditions, particularly at night, make it more difficult for the system to recognize road signs reliably. To ensure the current top speed limitations are displayed as accurately as possible, the data of the navigation road map should be up-to-date.

The functionality of the road sign recognition may be impaired in the following situations and may lead to incorrect information being displayed:

- heavy fog, rain or snow
- if signs are covered by objects
- If driving at close proximity to a vehicle driving ahead
- Strong light in the camera lens
- if the windscreen in front of the interior mirror is misted over, soiled or covered by stickers, etc.
- as a result of incorrect detection by the camera
- if the top speed limitations stored in the navigation system are incorrect
- in areas not covered by the navigation system
- in the event of deviations from the navigation, e.g. due to modified road layouts
- when overtaking buses or trucks with speed limit stickers
- if road signs do not correspond to the standard
- when calibrating the camera immediately after vehicle delivery.

Supplementary sign recognition

Only additional characters with symbols (icons) can be recognized by the system, such as "in wet weather", "in rain/snow", "truck" or "trailer", etc. Text notes on additional characters can generally not be read or interpreted.

G12 Driver Assistance Systems

11. Road Sign Recognition

Additional information is requested by the system from the vehicle electrical system before displaying speed limits or no overtaking signs with restrictive validity. For example, for "in wet weather" signs the status of the wiper is evaluated or for "in frost/snow" the temperature value of the outside temperature sensor is evaluated.

Temporal restrictions of the speed limit or no overtaking sign can only be evaluated correctly if the validity duration is stored in the navigation map and the clock is set correctly in the vehicle. Otherwise, the speed limit or the no overtaking sign is displayed as currently valid.

The trailer signal for vehicles in trailer towing is not evaluated for the display of speed limits as the speed limits for vehicles with trailer are specific to the national market and dependent on the trailer type.

Other additional characters are not recognized. The speed limit or the no overtaking sign is then displayed as currently valid without the interpretation of the additional character.

Road signs on parallel, branching-off or merging roads and on exits

Parallel roads are not recognized, neither by the KAFAS stereo camera nor with the help of the navigation map. Signs on these roads can be recognized and displayed as speed limits or no overtaking for the current road.

Speed limits and no overtaking signs for forking or emerging roads are generally also assumed and displayed for the current road.

Speed limits for exits off highways with or without an arrow as an additional character are generally evaluated correctly and suppressed in the display if driven past. This is only the case if the data on the navigation map is up-to-date.

In the case of gantry signs on the highway with different, lane-dependent speed limits, the speed limit which is closest to the vehicle's lane is displayed. There is no adaptation of the display after a later lane change.

Information signs in the road sign surroundings

Information signs with speed limits or no overtaking stipulations, such as at border crossing points with information on the different legal maximum speeds for single-lane roads and highways, may be incorrectly recognized as currently valid and displayed. The same applies to information signs with different color configurations, for example for minimum or recommended speeds.

Stickers on vehicles

Stickers with a speed limit on vehicles ahead or overtaken, such as trucks, buses, trailers or construction machinery, etc., may be incorrectly recognized as a currently valid speed limit and displayed.

Town/city limits

If the sign for the entrance to a village/town is not clearly recognized and the data from the navigation map is not up-to-date, the speed limit at the entrances to and exits from villages/towns may be displayed incorrectly.

Legal changes

If legally prescribed maximum speeds change, then these are only available after a software update. Up until the update the original, current but no longer valid speed limits are displayed.

G12 Driver Assistance Systems

11. Road Sign Recognition

General no overtaking signs

No overtaking signs are only displayed if these are also signs posted. General no overtaking stipulations, for example that apply at level crossings or are marked by a continuous white line on the roadway, are not displayed unless an additional sign is present.



The system does not replace the personal assessment of the traffic situation. Due to system restrictions and functional limitations, it may transpire that warnings and orders are not issued, are issued too late or are unwarranted. The road sign recognition supports the driver and does not replace the human eye.

G12 Driver Assistance Systems

12. Proactive Active Driving Assistant

The proactive Active Driving Assistant points out to the driver the ideal time at which to release the accelerator in order to reduce consumption, thus enabling the driver to save fuel.

Data from the navigation system is evaluated as the basis for the calculation. Using this data, sections of road ahead that require a reduction in speed can be detected in good time.

Relevant sections of road are:

- Intersections
- Bends
- Crossroads
- Roundabouts
- Entrances to towns
- Top speed limitations
- Highway exits

The proactive Active Driving Assistant function is available in the G12 in conjunction with the Navigation System Professional optional equipment (OE 609).

To ensure the coasting function is used to its full potential, the proactive Active Driving Assistant takes into account whether coasting is currently possible and adapts the time that the information is issued accordingly. The proactive Active Driving Assistant actively cancels coasting if it is possible to reach a section of road ahead in coasting overrun mode.

The proactive Active Driving Assistant helps drivers who are not familiar with the route or area to drive more efficiently.

Display



G12 proactive Active Driving Assistant displays in the instrument cluster

An indicator in the instrument cluster or Head-Up Display (only with optional equipment OE 610) alerts the driver that he is on a section of road relevant for the proactive Active Driving Assistant and gives him the option to react accordingly.

The driver can activate or deactivate the indicator in the Head-Up Display separately.

G12 Driver Assistance Systems

12. Proactive Active Driving Assistant





The alert is issued even if the section of road ahead cannot yet be seen by the driver. This information is displayed in the instrument cluster or Head-Up Display (optional equipment OE 610) until the road section is reached. If the vehicle is decelerated considerably before reaching the road section, the indicator goes out before the section is reached.

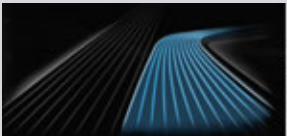

Proactive Active Driving Assistant symbol in the instrument cluster and Head-Up Display

The maximum length of road section that can be displayed is restricted to approximately 1500 m.

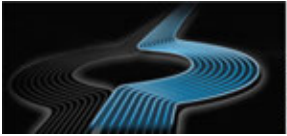
An additional symbol displays the detected road section in the instrument cluster.

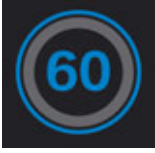
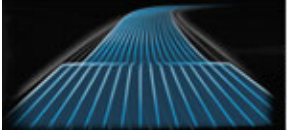
Display in the instrument cluster (additional symbol)	Display in central information display	Explanation
		Cornering situation on the route
		Roundabout on the route
		Stretch of road with bends
		Speed limit on the route

In the driving style analysis display on the central information display information is shown when a corresponding road section lies ahead.

G12 Driver Assistance Systems

12. Proactive Active Driving Assistant

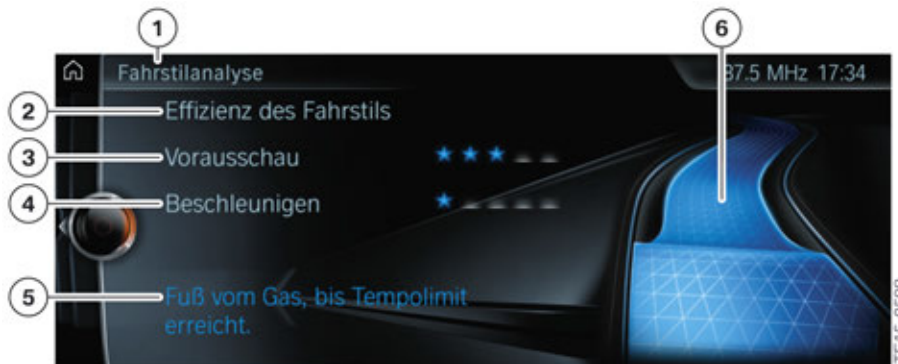

Driving style analysis display in central information display

Index	Explanation
1	"Driving style analysis" menu
2	Efficiency of driving style table of values
3	Forecast table of values
4	Acceleration table of values
5	Display of ECO PRO tips
6	Symbolized road route

In the driving style analysis view the driver also has the option of displaying information on his driving style.

The ECO PRO driving style analysis display consists of a symbolized road route and a table of values. The road symbolizes the efficiency of the driving style. The more efficient the driving style the smoother the route. The table of values contains stars. The more efficient the driving style, the more stars there are in the table and the quicker the bonus range increases.

ECO PRO notes are displayed during the journey as support for an efficient driving style.

G12 Driver Assistance Systems

12. Proactive Active Driving Assistant

12.1. Operation

To use the proactive Active Driving Assistant, ECO PRO mode or ECO PRO+ mode must be activated via the driving experience switch.



G12 switch block with driving experience switch

The proactive Active Driving Assistant can be switched on and off in the ECO PRO configuration menu.

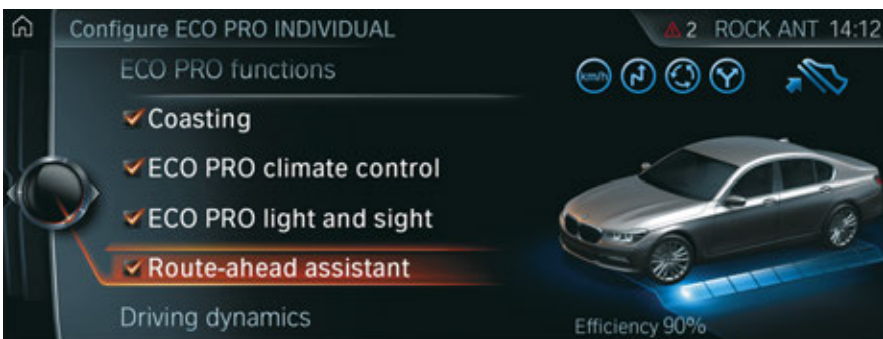

G12 ECO PRO view in the CID settings menu

To call up the display of the driving style analysis, make the following selection via the controller:

- "My Vehicle"
- "Technology in action"
- "Driving style analysis"

G12 Driver Assistance Systems

12. Proactive Active Driving Assistant



Driving style analysis view on the CID

The proactive Active Driving Assistant can be used when the route guidance is either active or inactive. When the route guidance is not active, the most likely route is used for evaluation. However, the calculation can be performed more accurately, and therefore more efficiently, when the route guidance is active.



The reliability of the system depends on the up-to-dateness and quality of the navigation data.

12.2. Limits of the system

The proactive Active Driving Assistant is not available in the following situations:

- Speed below 50 kph
- Temporary and variable top speed limitation, such as on building sites
- Quality of navigation data insufficient
- Cruise control active
- Trailer towing

G12 Driver Assistance Systems

13. Alertness Assistant

The attentiveness assistant helps to avoid accidents caused by tiredness on long, monotonous journeys. It is part of the Active Protection equipment (OE 5AL) included in the basic equipment.

A change in the driver's driving behavior is perceived by the attentiveness assistant. In the event of increasing inattentiveness or if the driver is tired, the alertness assistant shows a display recommending that the driver take a break as a Check Control message in the central information display (CID).

The alertness assistant is automatically active after each engine start from a speed of roughly 70 km/h. If the system is active, a driving behavior profile is created at the beginning of a journey. The following criteria are taken into consideration:

- Personal driving style, for example the steering behavior
- Driving conditions, for example the time or journey duration
- Breaks during a long journey
- Journey duration.

13.1. Operation

If the changed driving behavior differs markedly from the taught-in driving behavior of the alertness profile, the alertness assistant shows a break recommendation in the central information display (CID).

While the display is shown on the central information display (CID) the following settings can be selected using the controller:

- "Do not ask again"
- "Places to stop"
- "Remind me later" (in this case the break recommendation appears again after a journey duration of 20 minutes).

The break recommendation is only displayed once during an uninterrupted journey (except when "Remind later" is selected).

After a break a new break recommendation is not shown during the next 45 minutes of the journey. The system is reset if a break is longer than 50 minutes or if the break lasts longer than the last driving time. The driving behavior is re-taught.

The attentiveness assistant can be switched on and off in the iDrive menu. The driver can also set the level of sensitivity in this menu

by making the following selection via the controller:

- "My Vehicle"
- "Vehicle settings"
- "Attentiveness Assistant"
- Select desired settings.

G12 Driver Assistance Systems

13. Alertness Assistant



Alertness assistant display on the CID

Index	Explanation
1	"Alertness Assistant" menu
2	Additional note for the driver
3	"Sensitive"
4	"Standard"
5	"Off"

The settings differ from one another as follows:

Selected setting	Explanation
"Sensitive"	The break recommendation is issued earlier (significantly more sensitive or in other words earlier output compared to the "Standard" setting).
"Standard"	The break recommendation is issued with a defined value (in the same way as for BMW models up to now).
"Off"	A break recommendation is not issued.

G12 Driver Assistance Systems

13. Alertness Assistant

13.2. Limits of the system

The functionality may be impaired in the following situations and no warning or an incorrect warning may be issued:

- If the clock is set incorrectly
- If the speed is predominantly below approximately 70 km/h
- If the driver adopts a sporty driving style, for example rapid acceleration or fast cornering
- In active driving situations, for example frequent lane changes
- Poor road condition
- Strong crosswind.



The system does not relieve the driver of personal responsibility for correctly judging his physical condition. Increasing inattentiveness or fatigue may not be detected at all or in time.

G12 Driver Assistance Systems

14. Night Vision

In the G12 the Night Vision system is available in the form of BMW Night Vision with person and animal recognition optional equipment (OE 6UK).

Night Vision detects people and animals in optimum conditions at night up to a distance of approximately 100 m away and therefore assists the driver especially on dark and difficult stretches of road, such as when driving on single-lane roads with adjacent woods.

In potentially dangerous situations, the system warns the driver of people and animals on the road.

The Night Vision camera integrated in the BMW radiator grille records the area in front of the vehicle and sends the data to the Night Vision electronics (NVE).



G12 Night Vision camera

Heating is switched on to avoid ice forming on the camera at temperatures below 5° C.

The image data is analyzed by the Night Vision electronics control unit and the corresponding image information is sent to the head unit via the Color Video Blanking Signal.



G12 Night Vision electronics (NVE) control unit

G12 Driver Assistance Systems

14. Night Vision

Hot objects with outlines that resemble people or animals are detected by the system and can be displayed on the central information display if necessary.

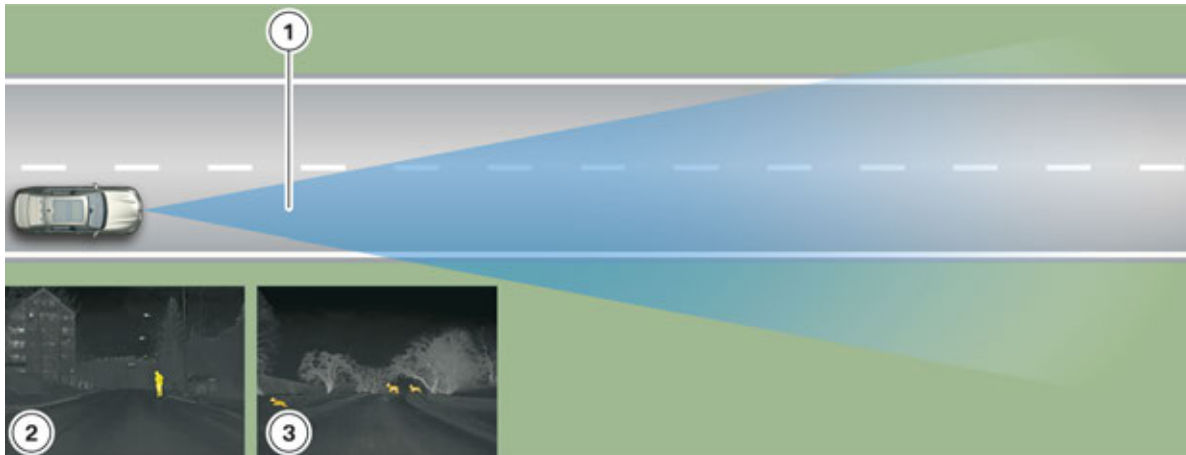

G12 Night Vision detection range

Index	Explanation
1	Night Vision camera detection range
2	Night Vision camera image showing detected person (display on the central information display)
3	Night Vision camera image showing detected animals (display on the central information display)

Object detection range

- Person recognition: up to about 100 m
- Recognition of large animals: up to about 150 m
- Recognition of medium-sized animals: up to about 70 m

Night Vision detects people and determines their position and distance from the vehicle. Taking into account the driving speed and steering angle, the system calculates whether there is a potential risk and displays a warning sign (early warning) in the instrument cluster and in the Head-Up Display, if present.

In critical situations a warning signal also sounds (acute warning).

The warning threshold values are also dependent on whether the person or the animal is moving or standing still. This is highlighted in the following graphic.

Early warning

The early warning is effected if a person or animal is detected inside the warning range. The early warning shows, depending on the location of the person or animal, a person or animal in yellow which is located inside the actual lane or is moving into the lane. Animals from a certain height can be detected, for example deer.

G12 Driver Assistance Systems

14. Night Vision

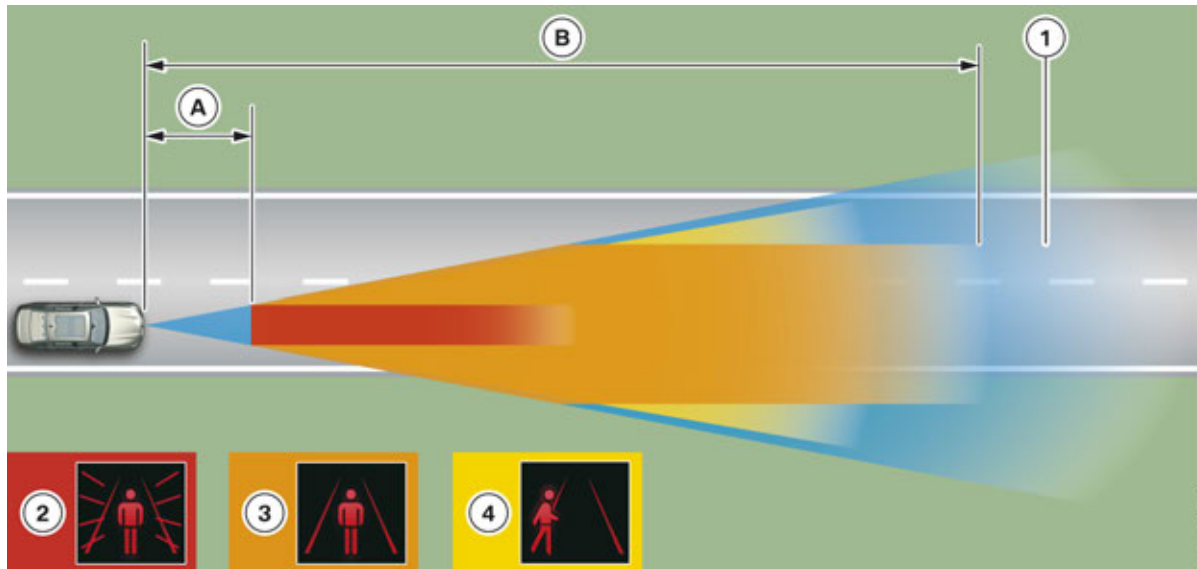

G12 Night Vision warning ranges (early warning)

Index	Explanation
A	Minimum distance about 8 m
B	Maximum distance for early warning of pedestrians about 100 m (the length depends on the driving speed)
1	Detection range of the Night Vision camera (opening angle about 24°)
2	Acute warning range when a person is detected
3	Warning range, early warning (person on the roadway)
4	Warning range, early warning (person crosses the roadway)

Acute warning

The acute warning is only effected in the case of immediate danger of a collision. The time of the acute warning is measured so that a collision can only be avoided by immediate emergency braking or by swerving. With the acute warning the brakes of the vehicle are prepared for emergency braking.

The acute warning in the instrument cluster and in the Head-Up Display shows a red flashing person or animal symbol on the roadway. In addition, an acoustic warning signal is sounded.

G12 Driver Assistance Systems

14. Night Vision

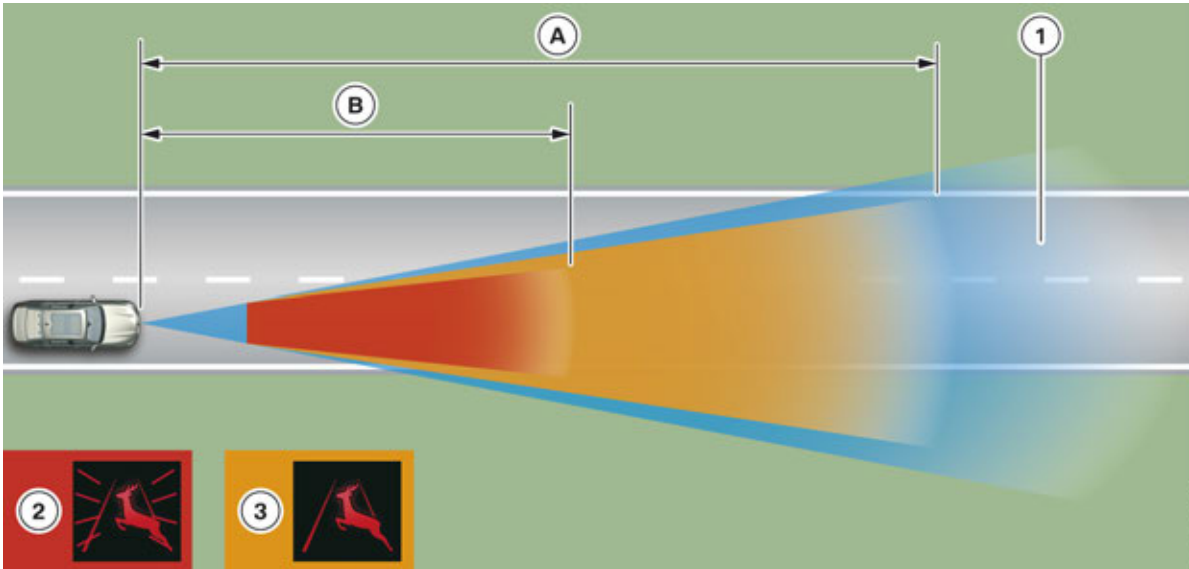

G12 Night Vision warning ranges (acute warning)

Index	Explanation
A	Maximum distance for early warning of animals about 160 m (the length depends on the driving speed and the size of the animal detected)
B	Maximum distance for acute warning of animals about 100 m (the length depends on the driving speed and the size of the animal detected)
1	Detection range of the Night Vision camera (opening angle about 24°)
2	Acute warning range when an animal is detected
3	Early warning range (the width of the detection range depends on the size of the animal and how it is moving)

Display in the central information display (CID)

The pedestrian or animal warning is effected irrespective of the representation of the Night Vision camera image in the central information display CID.

The warning is no longer shown on the central information display, but instead only appears in the instrument cluster and on the Head-Up Display. If the Night Vision camera image is active, identified pedestrians and animals are shown in yellow.



Night Vision camera image on the central information display showing detected people

G12 Driver Assistance Systems

14. Night Vision

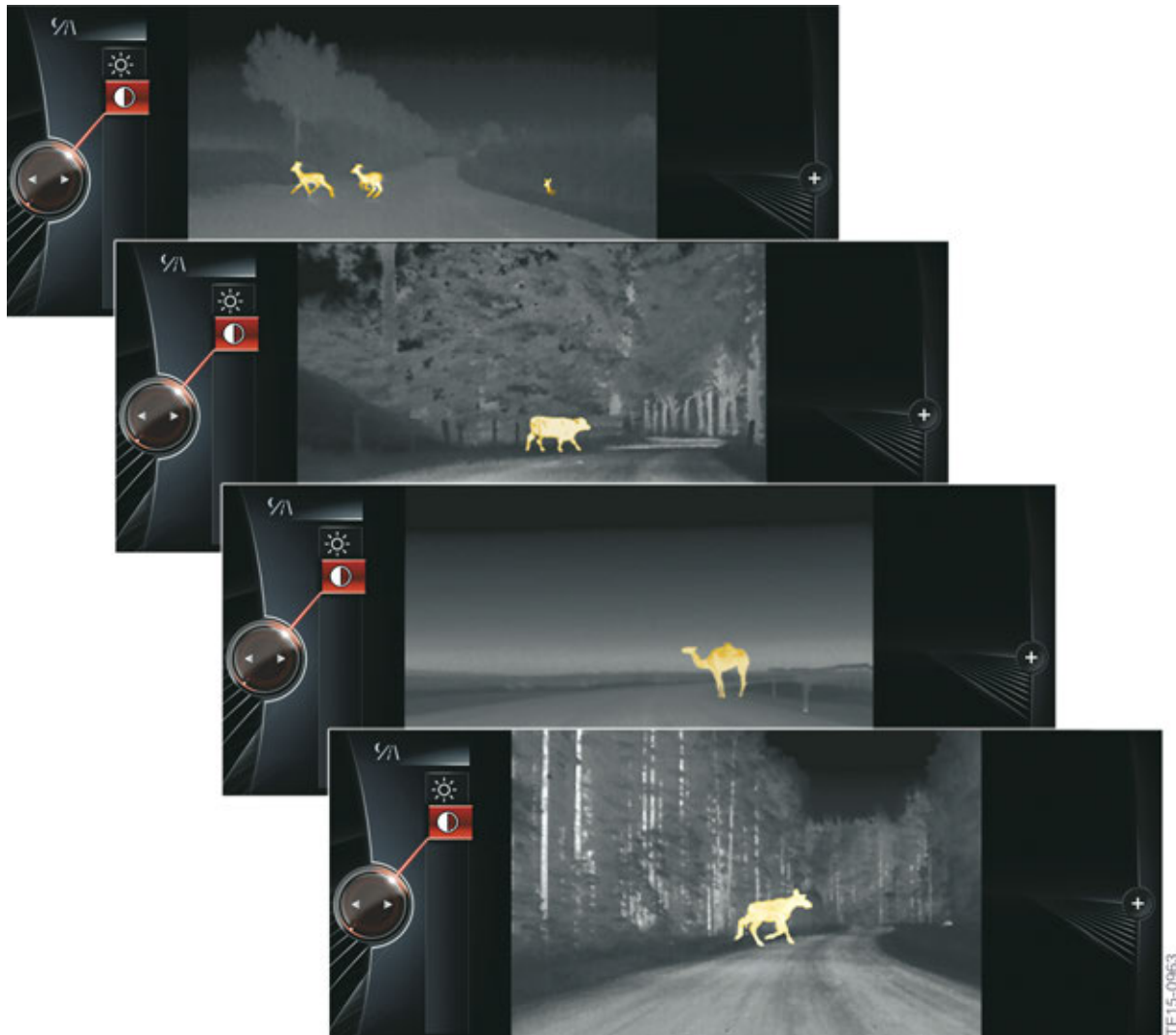

Night Vision camera image on the central information display showing detected animals

G12 Driver Assistance Systems

14. Night Vision

14.1. System wiring diagram

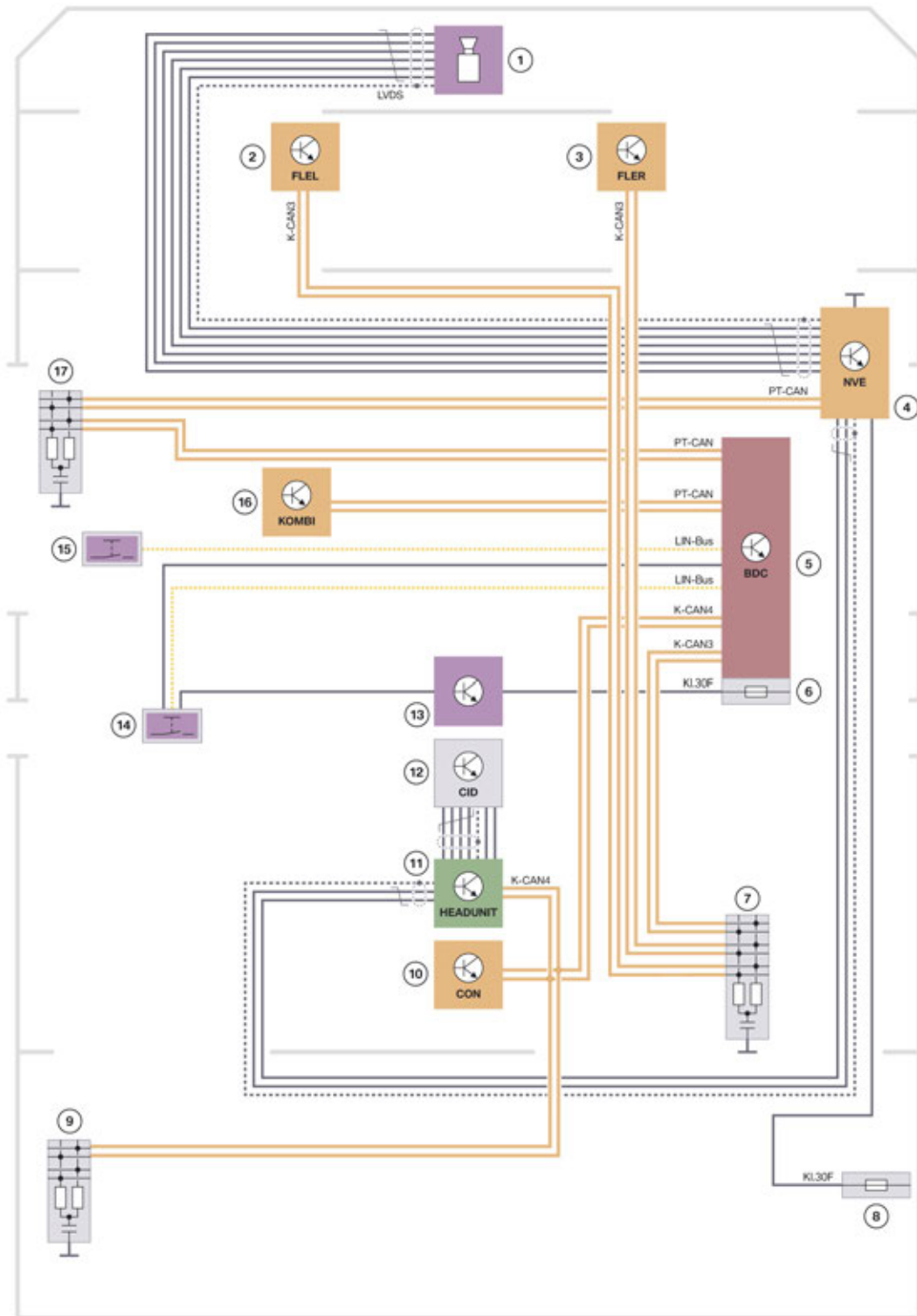

TE15-0519

G12 Night Vision system wiring diagram

G12 Driver Assistance Systems

14. Night Vision

Index	Explanation
1	Night Vision camera
2	Frontal Light Electronics, Left (not used with the US NVE system)
3	Frontal Light Electronics, Right (not used with the US NVE system)
4	Night Vision Electronics
5	Body Domain Controller (BDC)
6	Fuse in the Body Domain Controller BDC
7	CAN terminator
8	Fuse for rear right power distribution box
9	CAN terminator
10	Controller CON
11	Head Unit High 2
12	Central information display CID
13	Audio control panel
14	Intelligent Safety button
15	Light operating unit with integrated button for Night Vision
16	Instrument panel KOMBI
17	CAN terminator

G12 Driver Assistance Systems

14. Night Vision

14.2. Operation

Night Vision is automatically switched on every time the vehicle sets off when it is dark. The warning functions are therefore issued irrespective of the view on the central information display. The driver can switch the Night Vision camera display on and off by pressing the Night Vision button in the light operating unit.

It is also possible to set the brightness and contrast of the Night Vision display via the iDrive.



G12 button for thermal imaging camera/Night Vision

Index	Explanation
1	Night Vision button

G12 Driver Assistance Systems

14. Night Vision

14.3. Limits of the system

The functionality may be impaired in the following situations and no warning or an incorrect warning may be issued:

- On steep summits or dips and tight bends
- If the camera is dirty or the protective screen is damaged
- In heavy fog, rain or snow
- If the outside temperatures are very high

The person and animal recognition may also be impaired or may not issue the usual warnings. This can occur in the following cases:

- If the person or animal is fully or partially hidden, particularly the head
- If the person is not in an upright position, e.g. if they are lying down
- If a bike has non-conventional wheels, e.g. recumbent bicycle
- If the system has been affected mechanically, e.g. after an accident

In certain cases small animals may be entirely visible on the central information display, but may not be identified by the object detection. As a consequence, a warning is also not issued.



The system does not relieve the driver of personal responsibility for correctly judging the visibility and traffic situation. The driver is solely responsible for the vehicle and the speed at which it is driven.

G12 Driver Assistance Systems

15. Cameras

The optional equipment Surround View (SA 5DL) is part of ZDB Driver Assistance Plus and provides support when parking, maneuvering, as well as at unclear exits and crossroads. In the G12, the Surround View optional equipment (OE 5DL) is only available in conjunction with the rear view camera optional equipment (OE 3AG).

Panorama View is part of the Surround View optional equipment (OE 5DL).

The rear view camera is available as standard equipment (OE 3AG).

15.1. Surround view

The Surround View optional equipment (OE 5DL) shows the vehicle surroundings and displays them in TOP View and 3D View on the central information display.

The system comprises the front camera, the two cameras integrated in the exterior mirrors, the rear view camera (RFK) and the top rear side view camera (TRSVC) control unit. The cameras record the area from various, selectable angles and send this information to the TRSVC control unit via Ethernet. The images from the four cameras are combined into a panorama view around the vehicle from different angles using 3D computer graphics. The video signals are transmitted from the TRSVC control unit via an Ethernet line to the head unit. From there the video signal is transmitted to the central information display via an Automotive Pixel Link line. The driver can choose from preset views or can freely select the view (for example towbar zoom and car wash entrances).

In addition, assistance functions such as guidance lines can be shown on the central information display.



G12 configuration menu view for Obstacle marking and Parking assistance lines on the CID

Index	Explanation
1	"Parking assistance lines"
2	"Obstacle marking"

G12 Driver Assistance Systems

15. Cameras

The following camera angles can be displayed:

- Automatic camera angle
- Side view
- Front camera
- Panorama View
- Reversing camera
- Moving camera angle

15.1.1. Automatic camera angle

The system automatically shows the most appropriate camera angle depending on the driving situation, thus providing the driver with optimum assistance when parking and maneuvering. The automatic camera angle shows a steering-dependent view and takes into account the respective direction of travel and the distance information from the Park Distance Control (PDC).

As soon as obstacles are detected, the view changes to a fixed display of the area in front of or behind the vehicle, or changes to the corresponding side view if required.

15.1.2. Side view

This view helps the driver to position the vehicle next to the curb or other obstacles at the side of the vehicle by displaying the side surroundings. The side view is from the rear to the front and automatically focuses on potential obstacles if there is a collision risk.

Both the left and right sides of the vehicle are recorded.

15.1.3. Front camera

The front camera supports the driver when parking and maneuvering. The area in front of the vehicle is recorded by the front camera and shown on the central information display. The front camera view cannot be selected separately. The driver must select the "Auto" camera angle to view it or if desired, switch on the "Panorama View" function (see next section).

G12 Driver Assistance Systems

15. Cameras

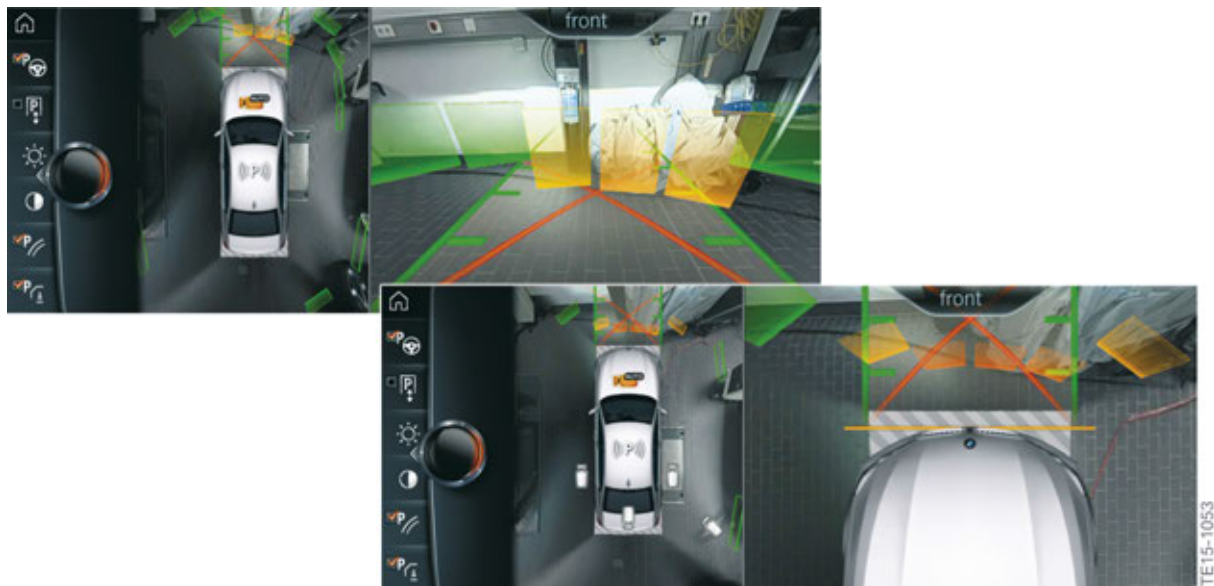

G12 front camera view on the CID

Areas around the vehicle that are not visible due to the camera angle of view are shown with grey crosshatching.

15.1.4. Panorama View

Panorama View enables the driver to see the cross traffic at blind exits and Intersections before proceeding and provides the driver with optimum assistance in this situation. Road users that are hidden by obstacles to the side of the vehicle are sometimes only seen by the driver very late or not at all. To improve the view, the front and rear view cameras record the lateral roadway area. Depending on which drive position is engaged, the front or rear view camera can be activated.



G12 Panorama View on the CID

G12 Driver Assistance Systems

15. Cameras

Yellow lines in the screen display mark the front and rear ends of the vehicle. The camera image is badly distorted in some areas and is therefore not suitable for estimating distances.

The function can be activated using the Panorama View button. Press the button again to deactivate the function. The Panorama View function is automatically deactivated at speeds above approximately 15 km/h. Panorama View is also deactivated after a drive position change (from "D" to "R" or the opposite).

Panorama View (GPS-based)

The GPS-supported, automatic activation of the Panorama View function has been implemented in the G12.



G12 automatic switch on at a set activation point

Positions, at which the Panorama View should switch itself on automatically, can be saved as activation points, provided that a GPS signal is received. A maximum of ten activation points can be saved for the front camera.

To save the activation points, the driver must proceed as follows:

Stop after reaching the place where the Panorama View should switch itself on automatically. Press the Panorama View button and then tilt the controller to the left. Then select "Add activation point" (the current position is displayed) and confirm by selecting "Add activation point".

G12 Driver Assistance Systems

15. Cameras



G12 setting activation points

Index	Explanation
1	"Add activation point"

If possible, the activation points are saved with the town/city and street or with the GPS coordinates. The direction of travel is also saved in conjunction with the activation point.

The driver can display the saved activation points on the central information display.

G12 Driver Assistance Systems

15. Cameras



G12 displaying activation points

Index	Explanation
1	"Show activation points"

The use of activation points can be switched on and off via iDrive.

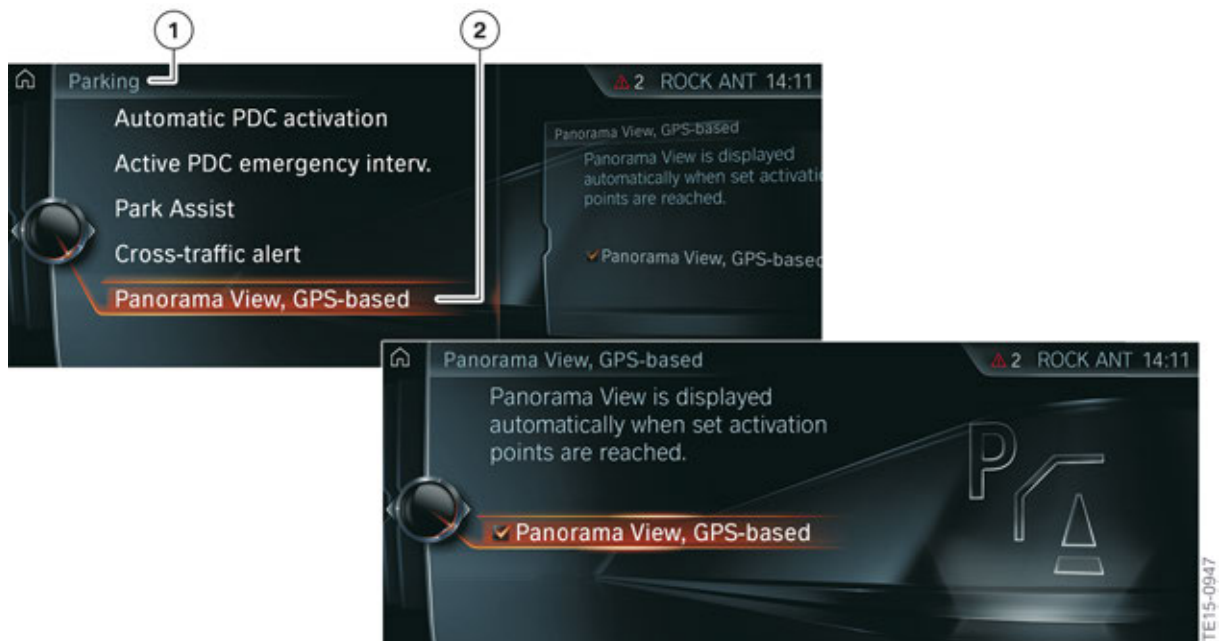

G12 Panorama View activation menu on the CID

G12 Driver Assistance Systems

15. Cameras

Index	Explanation
1	"Parking" menu
2	"Panorama View, GPS-based"

15.1.5. Reversing camera

The rear view camera supports the driver when parking and maneuvering. The area behind the vehicle is recorded by the rear view camera and shown on the central information display.



G12 rear view camera, view on the CID

15.1.6. Moving camera angle

When the moving camera angle is selected, a circular trajectory is shown around the vehicle on the central information display. Predetermined angles can be selected on the circular trajectory by turning the controller or using the touch function.

In vehicles with the gesture control optional equipment (OE 6U8), the moving camera angle can also be controlled in this way.

The current angle is identified by a camera symbol. Depending on the view, the surroundings of the vehicle or a partial area of the surroundings are shown on the central information display.

G12 Driver Assistance Systems

15. Cameras



G12 exterior camera view (moving camera angle) on the CID

To leave this view, tilt the controller to the side, press it or touch the highlighted camera symbol via the touch screen.

If gesture control is being used, the gesture symbol is shown on the right half of the central information display screen.



G12 rotating the camera view using gesture control

G12 Driver Assistance Systems

15. Cameras

15.2. Overview of exterior camera operating menu

Once the camera systems have been activated successfully the driver has the option of selecting the appropriate view or camera via iDrive.



G12 switch block with Panorama View button

Index	Explanation
1	Parking assistance button
2	Panorama View button

The camera systems can be activated (depending on the vehicle equipment) as follows:

- Manually by pressing the parking assistance button or the camera button (Panorama View)
- By engaging drive position "R"
- Automatically via the "Auto PDC" function
- Automatically via the GPS-supported automatic activation of the Panorama View function, provided that activation points have been saved

G12 Driver Assistance Systems

15. Cameras

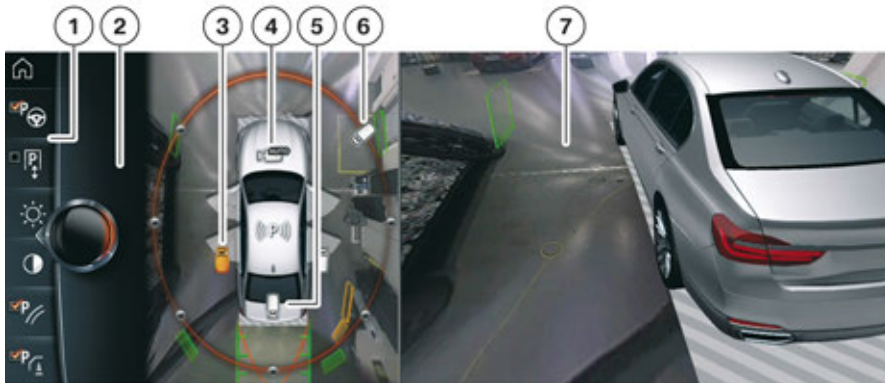

G12 exterior cameras view (camera angles) on the CID

Index	Explanation
1	Toolbar
2	Selection window
3	Side view
4	Automatic camera angle
5	Reversing camera
6	Moving camera angle
7	Camera image

Other settings and options can be found in the toolbar, depending on the vehicle equipment. The following functions may be available:

- Switching the "Parking Maneuver Assistant" function on and off
- "Brightness" range of adjustment
- "Contrast" range of adjustment
- Switching the "Parking assistance lines" on and off
- Switching the "Obstacle marking" on and off
- Activating the "Car wash" function
- "Settings" menu (various settings can be made, such as use of the activation points with Panorama View)

G12 Driver Assistance Systems

15. Cameras



G12 operating menu for exterior cameras and Parking Maneuver Assistant

G12 Driver Assistance Systems

15. Cameras

15.3. Assistant function

If required, the driver can receive additional assistance from the "Car wash" functions.

15.3.1. Car wash view

The car wash view assists the driver when entering a car wash. When the car wash view is selected, immediately before entering the car wash, a bird's eye view is displayed on the central information display. To enable the driver to align the vehicle more easily, at the same time the vehicle's tire tracks are shown on the display.

The car wash view can be activated via iDrive in the toolbar under the "Car wash" menu item.

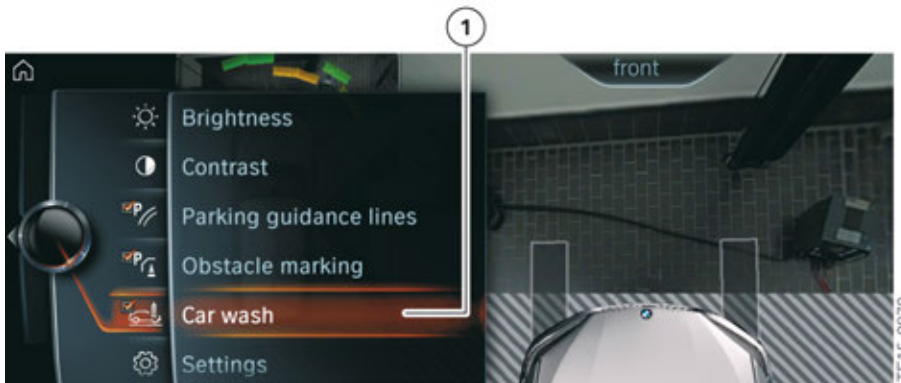

G12 PDC car wash view on the CID

Index	Explanation
1	"Car wash"

15.3.2. Side protection

The side protection warns against obstacles at the side of the vehicle and thus supports the driver when parking and maneuvering.

To protect the sides of the vehicle from collisions with obstacles, additional obstacle markings are shown to the side of the vehicle on the central information display if necessary, these obstacles are tracked by the nearest camera.

G12 Driver Assistance Systems

15. Cameras



G12 side protection view (additional obstacle markings)

More information on the side protection function can be found in section 18.

15.3.3. Door opening angle

When the vehicle is stopped and the selector lever position "P" is engaged, the maximum opening angle of the doors is displayed on the central information display.

If there is an obstacle near the door and it is detected by the side protection, this is marked on the central information display. The obstacle marking display only points out objects in the area of the door. It is not possible for a view from the camera systems to be displayed, as the door area is simulated. Therefore, the driver is only informed that there is an object at the side of the vehicle; it is not certain that the door will definitely collide with the identified object. The driver must judge this for himself.

G12 Driver Assistance Systems

15. Cameras



G12 door opening angle view on the CID

The "Parking assistance lines" and "Obstacle marking" features already used in other BMW models can also be activated and deactivated via iDrive in the toolbar under the relevant menu items.



The camera systems do not relieve the driver of personal responsibility for correctly judging the traffic situation. There is still a risk of an accident. The driver's driving style should be adapted to the traffic conditions. The driver should check the traffic conditions and the vehicle's surroundings by looking around and react accordingly if required.

15.4. System components

Front camera

The front camera is installed in the center between the two front ornamental grilles on the G12.



G12 front camera

G12 Driver Assistance Systems

15. Cameras

Top view camera

The two top view cameras are installed in the exterior mirrors on the G12.



G12 left top view camera

Index	Explanation
1	Exterior mirror camera

15.4.1. Reversing camera

The rear view camera supports the driver when parking and maneuvering. The area behind the vehicle is shown on the central information display. Guidance lines integrated in the image provide the driver with additional assistance with distances, the turning circle and obstacle markings function, if required.

The driving lane lines are dependent on the steering angle and are continually adjusted when steering wheel movements are made.

The turning circle lines can only be shown in the rear view camera image in conjunction with the driving lane lines. The turning circle lines show the shape of the smallest possible turning circle on an even roadway. From a certain steering-wheel angle, only one turning circle line is shown.

The rear view camera is located in the tailgate handle strip.

G12 Driver Assistance Systems

15. Cameras



G12 rear view camera

The control unit is integrated in the rear view camera and is the bus user at K-CAN3. The video signals are transmitted directly to the Head Unit High 2 (HU-H2) via a CVBS line. An Ethernet connection for the rear view camera (on non 5DL cars) is being planned for a later version.

In vehicles with the Surround View optional equipment (OE 5DL) a rear view camera without an integrated control unit is installed. The reversing camera is connected to the TRSVC control unit via Ethernet in vehicles with Surround View (SA 5DL).

15.4.2. TRSVC control unit

The exterior cameras record the area around the vehicle from various angles and send this information to the TRSVC control unit via Ethernet. The video signals are transmitted from the TRSVC control unit to the head unit via an Ethernet line. The head unit transmits the signals to the central information display via an Automotive Pixel Link line.

The installation location of the TRSVC control unit is in the footwell on the driver's side.

G12 Driver Assistance Systems

15. Cameras

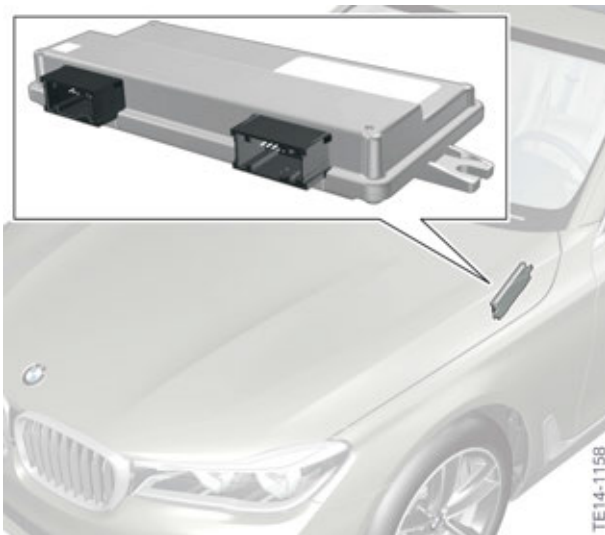

G12 TRSVC control unit

15.5. System wiring diagram

The system wiring diagram on the next page shows an overview of the system components used when parking and maneuvering the vehicle. Depending on the vehicle equipment, partial scopes may also be installed.

G12 Driver Assistance Systems

15. Cameras

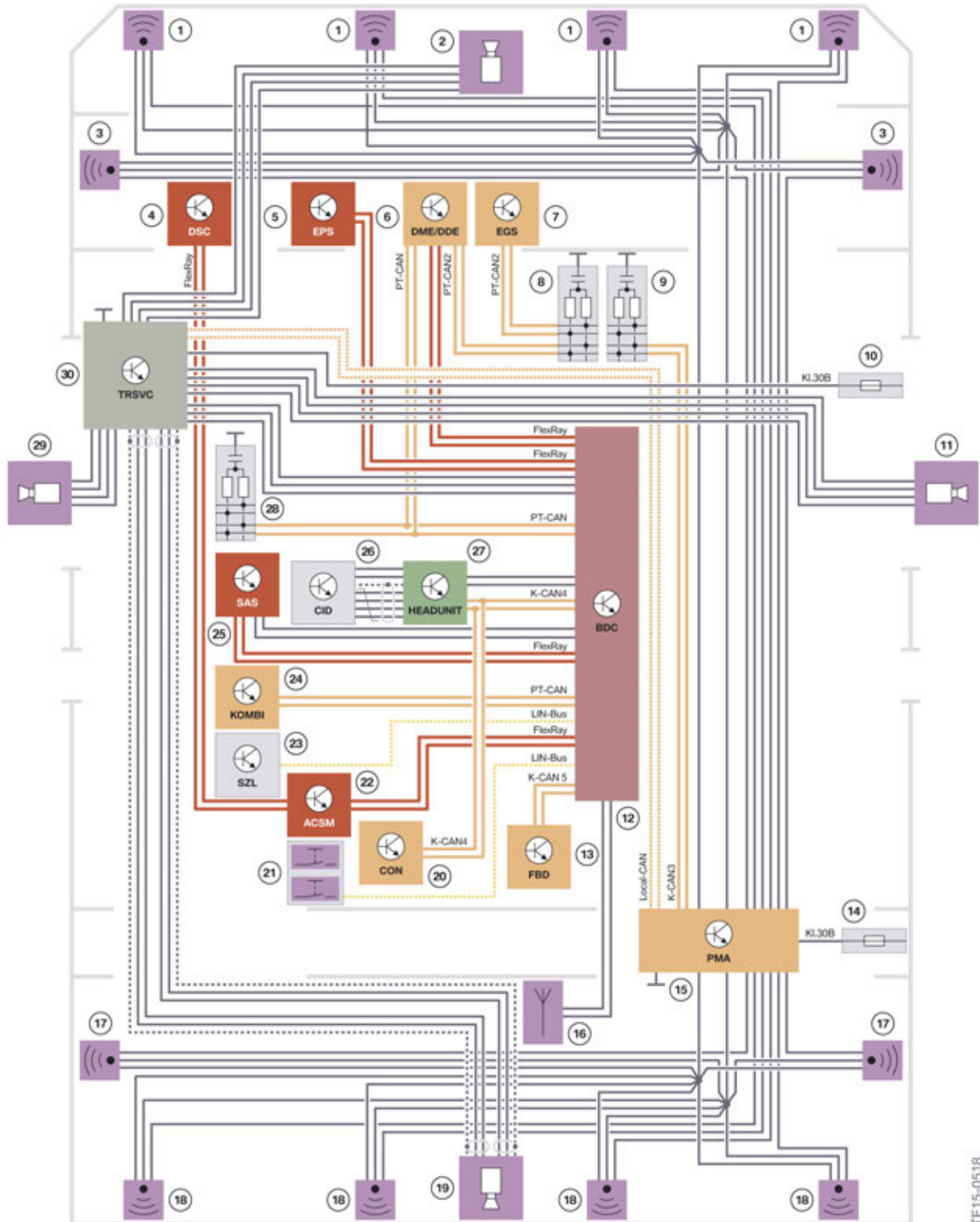

G12 parking and maneuvering system wiring diagram

TE15-0518

G12 Driver Assistance Systems

15. Cameras

Index	Explanation
1	Ultrasonic sensors for Park Distance Control, front
2	Front camera
3	Ultrasonic sensors for Parking Maneuver Assistant
4	Dynamic Stability Control (DSC)
5	Electronic Power Steering (EPS)
6	Digital Motor Electronics (DME)
7	Electronic transmission control (EGS)
8	CAN terminator
9	CAN terminator
10	Fuse for front right power distribution box
11	Right side view camera
12	Body Domain Controller (BDC)
13	Remote control receiver (FBD)
14	Fuse for rear right power distribution box
15	Control unit for Parking Maneuver Assistant (PMA)
16	Remote Control Parking aerial
17	Ultrasonic sensors, Park Distance Control, rear side
18	Ultrasonic sensors, Park Distance Control, rear
19	Rear view camera (RFK)
20	Controller (CON)
21	Parking assistance button and button for camera activation
22	Advanced Crash Safety Module (ACSM)
23	Steering column switch cluster (SZL)
24	Instrument panel (KOMBI)
25	Control unit for optional equipment system (SAS)
26	Central information display (CID)
27	Head Unit High 2 (HU-H2)
28	CAN terminator
29	Left side view camera
30	Top rear side view camera (TRSVC) control unit

G12 Driver Assistance Systems

16. Park Distance Control

Park Distance Control (PDC) assists the driver when maneuvering in and out of a parking space. The current distance from an obstruction is indicated by acoustic signals and on a visual display.



G12 Park Distance Control (PDC) view on the CID

The front and rear Park Distance Control (OE 508) is included in the G12 standard equipment.

The distance from an obstruction is measured by four ultrasonic sensors in the rear bumper panel and four additional ultrasonic sensors in the front bumper panel.

16.1. System components

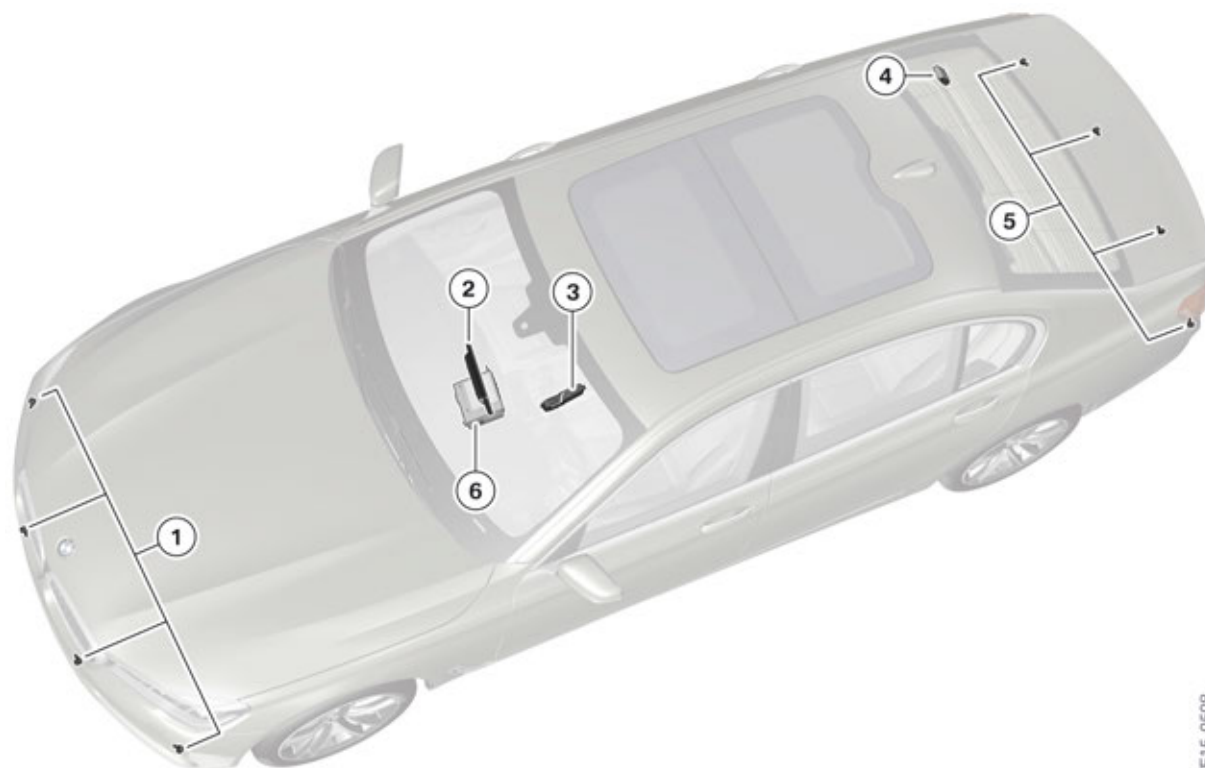

G12 Park Distance Control system components

G12 Driver Assistance Systems

16. Park Distance Control

Index	Explanation
1	Ultrasonic sensors for Park Distance Control, front
2	Central information display CID
3	Operating unit
4	Control unit for Parking Maneuver Assistant PMA
5	Ultrasonic sensors, Park Distance Control, rear
6	Head Unit High 2 (HU-H2)

Vehicles that do not have the Parking Maneuver Assistant but do have the Park Distance Control have a separate control unit, which is recognized as the PMA control unit by diagnosis and is also referred to by this name in the bus diagram. In other words, there is no longer a difference in the naming of the PDC and PMA control unit (there are however differences in the hardware design between the control units and the software is adapted to the equipment specification).



G12 control unit for Parking Maneuver Assistant (PMA)

16.2. Auto PDC

Automatic activation of the Park Distance Control not only with drive position "R" engaged, but also with "D" engaged, has been implemented in the G12.

Auto PDC is also activated automatically if the vehicle is approaching an object at a speed below approximately 5 km/h.

Use case:

The driver is driving along a road at approximately 50 km/h and after some time approaches an entrance gate on the right-hand side of the road. The entrance gate is 2.80 m wide and there is a wall on each side of it. The vehicle turns right to drive into the entrance gate. Let us assume that in this example space is very restricted and given the difficult curve radius the vehicle is approaching the left-hand wall of the entrance gate at a distance of less than approximately 0.6 m. In this case, the Park Distance Control would be activated automatically, if on approaching the wall the speed of the vehicle does not exceed approximately 4 km/h.

The Park Distance Control is activated automatically, if:

G12 Driver Assistance Systems

16. Park Distance Control

- there is an object closer than 0.6 m from the front of the vehicle when driving forwards
- there is an object closer than 1.5 m from the rear of the vehicle when reversing
- the speed driven does not exceed approximately 4 km/h

The PDC view is automatically displayed on the central information display. The activation distance of the Park Distance Control depends on the respective situation and therefore may vary.

A sound is only output if the detected object (in front of or behind the vehicle) is directly in the lane (risk of collision). If the detected object is not directly in the lane, there is only visual acknowledgement on the central information display.

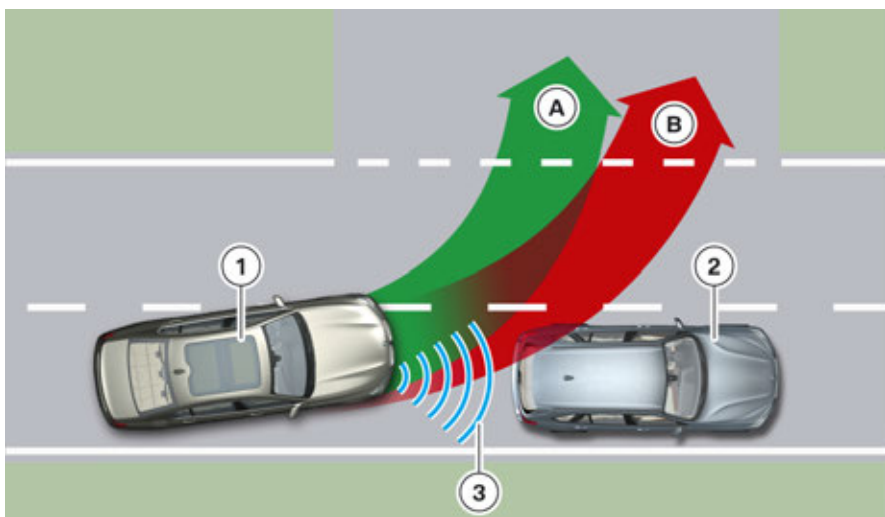

Automatic PDC

Index	Explanation
A	Lane without object contact (the driver receives visual acknowledgement)
B	Lane with object contact (the driver receives visual and acoustic acknowledgement)
1	Turning vehicle
2	Detected object
3	Detection of obstacle by the ultrasonic sensors

If an object has been detected by Auto PDC, the system must be reactivated so that it cannot be accidentally switched on, for example in a car wash. Reactivation is effected by:

- driving speed > 5 km/h
- drive position change

If a drive position change is made into neutral, the Park Distance Control is not activated automatically, again to avoid it being switched on, for example in a car wash.

The automatic switch-on function when obstacles are detected can be switched on and off via iDrive.

G12 Driver Assistance Systems

16. Park Distance Control

16.3. Active Park Distance Control

In G12 vehicles with the Parking Maneuver Assistant optional equipment (OE 5DP), the Park Distance Control function has been extended to include the active Park Distance Control function. This automatically brakes the vehicle to a halt when it is travelling at walking speed (< approximately 6 km/h) if an object is detected behind the vehicle.

If the accelerator pedal is pressed and an obstacle is detected, the brakes are preconditioned and gentle initial braking is initiated as a warning for the driver. If the accelerator pedal is not pressed and the vehicle is very close to the obstacle, the function brakes the vehicle with the maximum possible brake force until it comes to a standstill. This can potentially avoid a collision or reduce the damage.

The automatic brake intervention can be overridden at any time by pressing the accelerator pedal. Consequently, after the vehicle is automatically braked to a standstill, it is possible to continue to approach the obstruction by gently pressing the accelerator pedal.

The active Park Distance Control function can be switched on and off via iDrive.

If the Dynamic Stability Control (DSC) is switched off, then the active Park Distance Control is also deactivated. If the active Park Distance Control is switched on when the Dynamic Stability Control is switched off, the DSC is automatically switched on at the same time.



The system does not relieve the driver of personal responsibility for correctly judging the traffic situation. The driver should check the traffic conditions and the vehicle's surroundings by looking around and react accordingly if required.

16.4. Side protection

Vehicles with the Parking Maneuver Assistant optional equipment (OE 5DP) have side protection. Obstacles that are detected by the four side ultrasonic sensors integrated in the bumpers can be displayed by the Park Distance Control system.

Display in the central information display (CID)	Meaning
Colored markings	Warning of detected obstacles
Grey markings	The area next to the vehicle has not yet been recorded
No markings	No obstacles have been detected

The system only shows stationary obstacles that were earlier detected by the ultrasonic sensors when driving past.

It is not able to detect whether an obstacle has since moved. For this reason, the markings on the display are shown in grey after the vehicle has been stationary for roughly 13 seconds.

More information on the side protection function can be found in section 18.6.

G12 Driver Assistance Systems

16. Park Distance Control

16.5. Operation

The Park Distance Control system is enabled in the following situations:

- if drive positions R or D are engaged when driving readiness is switched on
- if the parking assistance button in the switch block next to the controller is pressed when driving readiness is switched on
- if Auto PDC is activated and all marginal conditions for automatic activation are met (see section 16.2 "Auto PDC").



G12 switch block with parking assistance button

Index	Explanation
1	Parking assistance button

16.5.1. Auto PDC

Automatic switch-on of this function when obstacles are identified can be switched on and off in the "Settings" menu using the controller. To do this proceed as follows:

- "My Vehicle"
- "Vehicle settings"
- "Parking"
- "Automatic PDC activation"
- Apply desired setting.

G12 Driver Assistance Systems

16. Park Distance Control

The setting is stored for the ID transmitter currently being used.



Automatic Park Distance Control on the CID

Index	Explanation
1	"Parking" menu
2	"Automatic PDC activation"

16.5.2. Active Park Distance Control

The active Park Distance Control function can be switched on and off in the "Settings" menu using the controller. To do this proceed as follows:

- "My Vehicle"
- "Vehicle settings"
- "Parking"
- "Active PDC emergency inter."
- Apply desired setting.

The setting is stored for the ID transmitter currently being used.

G12 Driver Assistance Systems

16. Park Distance Control

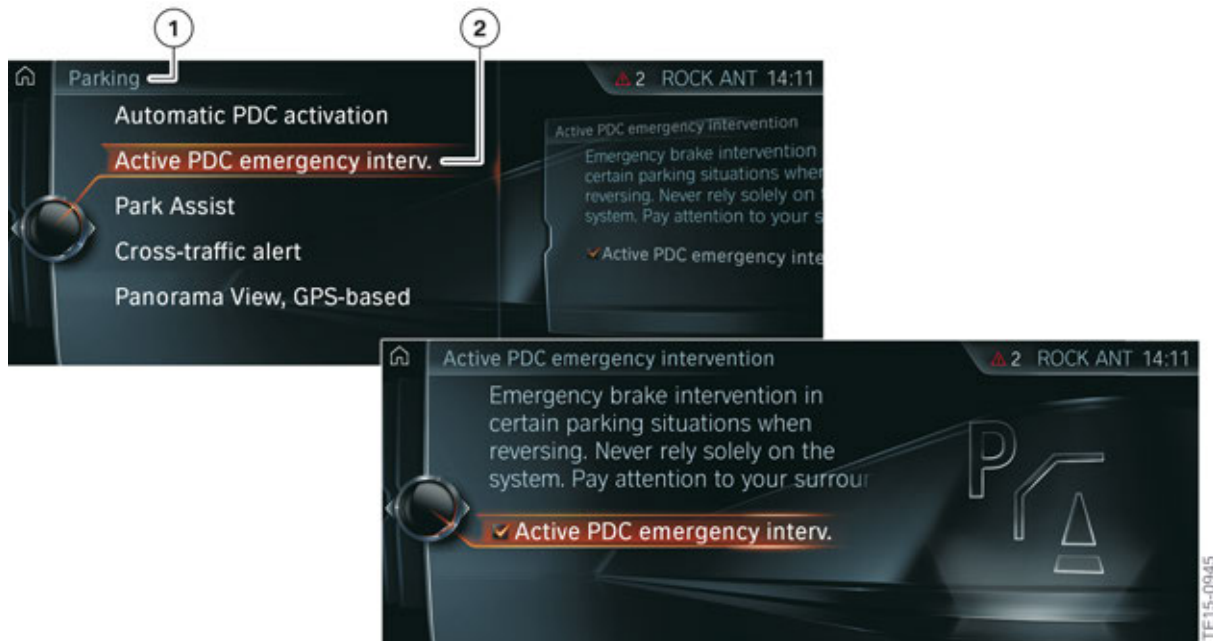

Active Park Distance Control on the CID

Index	Explanation
1	"Parking" menu
2	"Active PDC emergency inter."

16.5.3. Acoustic signal output

The driver is notified about the results of the distance measurements and the distance warnings acoustically via the audio speakers and optically via the central information display (CID). As the vehicle approaches an object, the corresponding position is indicated by an intermittent tone from the audio speaker. If, for example, an object is detected behind the vehicle to the left, the rear left speaker emits an acoustic signal. A continuous alarm sounds when the object is about 25 cm or less away. The volume of the acoustic signal of the Park Distance Control system can be adjusted in relation to the audio playback of the entertainment system.

G12 Driver Assistance Systems

16. Park Distance Control



Park Distance Control volume control menu on the CID

Index	Explanation
1	"System settings"
2	"Sound"
3	"Volume settings"
4	"PDC"

16.6. Deactivation criteria

Similar to other BMW models, the deactivation is distance-/speed-based. The switch-off is effected after a journey of about 50 m or at a speed over 36 km/h.

If a fault develops, a Check Control message ("PDC has malfunctioned. Have system checked.") is displayed in the central information display (CID). In addition, the detection range of the sensors is shown shaded in the central information display (CID).

G12 Driver Assistance Systems

16. Park Distance Control

16.7. Limits of the system

Due to the physical limits during the ultrasonic measurement, obstructions may not be detected by the Park Distance Control system. Several examples of this are shown below:

- if the objects are thin or wedge-shaped
- when the objects are low
- when objects that, due to their shape, have corners and sharp edges
- with snow
- if the objects have a porous surface.

A warning may also be displayed although there is no obstruction in the detection range. This may be the case in the following situations:

- when it is raining heavily
- if the sensors are heavily soiled or iced over
- if the sensors are covered with snow
- if the street surface is rough
- if there are bumps, e.g. speed bumps
- in large right-angled buildings with smooth walls, e.g. underground car parks
- due to heavy exhaust gas fumes
- due to other ultrasound sources.

To ensure the ultrasonic sensors remain fully operational, they must be kept clean and free of ice. When cleaning the sensors using a high pressure cleaner, avoid direct and sustained contact with a high-pressure water jet. Furthermore, when using high pressure cleaners, a distance of at least 30 cm from the sensors must be maintained.



The Park Distance Control cannot replace the driver's personal judgement of the traffic situation. Also check the traffic situation around the vehicle by looking around, otherwise there may be a risk of an accident as a result of road users or objects which lie outside the detection range of the Park Distance Control. Loud sound sources outside and inside the vehicle could drown out the PDC signal.

G12 Driver Assistance Systems

17. Cross-Traffic Warning

The cross-traffic warning is used for the first time in the G12. This warning assists the driver when maneuvering out of a parking space and in other everyday situations where it is difficult to see the traffic, such as at blind entrances and exits.

Depending on the vehicle equipment, the cross-traffic warning is available for the front and rear.

The system can detect objects that are approaching the vehicle from the side, either from the front or rear (depending on the vehicle equipment). The driver is made aware or, if necessary, warned of cross traffic by the cross-traffic warning when maneuvering out of a parking space or entering the cross traffic.

17.1. Functional principle

If a moving object is detected, which based on the current speed would be in the area in front of or behind the vehicle in approximately the next three seconds, a visual and acoustic warning is issued.

When a rear cross-traffic warning is issued, the LED in the mirror glass is also switched on. The Blind spot detection signal unit is used as an indicator. The indicator is switched on in either the left or right mirror depending on the direction from which the object is approaching the vehicle.

The cross-traffic warning works up to a speed of approximately 7 km/h. Another prerequisite of the function is that the side radar sensors are able to detect the road or approaching object. The radar sensors can detect objects up to approximately 30 to 40 m away from the vehicle.

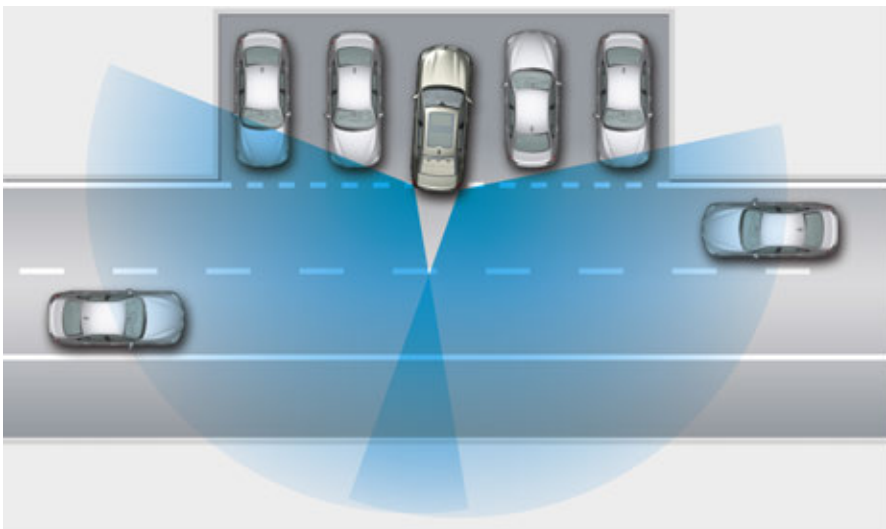

G12 cross-traffic warning example: maneuvering out of a parking space

Depending on the vehicle equipment, different versions of the cross-traffic warning and displays on the central information display are available.

G12 Driver Assistance Systems

17. Cross-Traffic Warning

17.2. Rear cross-traffic warning

The rear cross-traffic warning assists the driver when reversing out of a parking space and warns of potential collisions with cross traffic in traffic situations where it is difficult to see obstructions.

The rear cross-traffic warning function is included in the Active Driving Assistant (OE 5AS) optional equipment.

The warning is displayed in the Park Distance Control image on the central information display.

In conjunction with the rear view camera optional equipment (OE 3AG), the rear cross-traffic warning will be extended to include an additional display on the central information display in a later version. The warning will be shown in the form of a red bar in the camera's video screen.

The rear cross-traffic warning is enabled if the driver engages the "R" drive position or the Park Distance Control is active.

In vehicles with the Surround View optional equipment (OE 5DL), the rear cross-traffic warning is also enabled if Panorama View has been activated.

The rear cross-traffic warning is available at speeds from 0 to approximately 7 km/h.

17.3. Front cross-traffic warning

The front cross-traffic warning assists the driver when entering the cross traffic from exits and blind Intersections.

The front cross-traffic warning is included in the Active Driving Assistant Plus (OE 5AT) optional equipment. If the cross-traffic warning for the front of the vehicle is installed, the rear version is activated automatically.

The warning is displayed in the Park Distance Control image on the central information display.

The front cross-traffic warning is enabled if the Park Distance Control is active and the speed of the vehicle does not exceed approximately 7 km/h.

In vehicles with the Surround View optional equipment (OE 5DL), the front cross-traffic warning is also enabled if Panorama View has been activated.

Like the rear cross-traffic warning, the front cross-traffic warning function is available at speeds from 0 to approximately 7 km/h.

G12 Driver Assistance Systems

17. Cross-Traffic Warning

17.4. Displays

The respective peripheral region in the PDC view flashes red if vehicles are detected by the sensors.



G12 cross-traffic warning in the PDC view

In vehicles with the Surround View optional equipment (OE 5DL), the warning is shown on the central information display in the PDC view image and in the front camera and rear view camera video images in the form of a red bar.

If Panorama View is activated, the cross-traffic warning is shown in the form of a red bar on the central information display.



G12 Panorama View (front cross-traffic warning)

The cross-traffic warning is available to the driver for both the front and rear views.

G12 Driver Assistance Systems

17. Cross-Traffic Warning



G12 Panorama View (rear cross-traffic warning)

17.5. Operation

The cross-traffic warning can be switched on and off in the iDrive menu by making the following selection via the controller:

- "My Vehicle"
- "Vehicle settings"
- "Parking"
- "Cross-traffic alert"



G12 cross-traffic warning activation on the CID

G12 Driver Assistance Systems

17. Cross-Traffic Warning

Index	Explanation
1	"Vehicle settings"
2	"Parking"
3	"Cross-traffic alert" (switching the cross-traffic warning on and off)

If the cross-traffic warning has been activated in the iDrive menu, the function is switched on automatically as soon as the Park Distance Control or Panorama View is active.

The cross-traffic warning is deactivated automatically in the following situations:

- if the driver's vehicle is travelling at a speed higher than walking speed (threshold value approximately 7 km/h)
- if the steering and lane control assistant is active
- if the driver is currently parking using the Parking Maneuver Assistant

17.6. Limits of the system

The function may be restricted in the following situations:

- if there are other objects in the field of view of the sensors that are concealing the cross traffic
- In heavy fog, rain or snow
- if the bumper is dirty or iced up
- if stickers have been attached near the radar sensors on the bumper
- if the speed of the approaching vehicle is very high
- if crossing objects are moving very slowly
- on sharp bends

If a trailer socket is being used, for example to operate a trailer or bicycle carrier, the cross-traffic warning is not available for the area behind the vehicle.

G12 Driver Assistance Systems

18. Parking Maneuver Assistant

The Parking Maneuver Assistant PMA supports the driver in many ways. The assistant measures the size of a gap between cars and decides based on the result whether the gap is large enough on the one hand and relieves the driver of the task of maneuvering into the space on the other. The Parking Maneuver Assistant (OE 5DP) is optional equipment in the G12 and can only be ordered in conjunction with the rear view camera optional equipment (OE 3AG) and its offered as part of the ZDB - Driver Assistance Plus (5AS) package.

18.1. System components

Below is an overview of important sensors and operating elements:

- The parking assistance button is the central control panel for the Parking Maneuver Assistant function (position 8).
- Two additional ultrasonic sensors in the front bumper measure parking spaces while driving (position 1).
- The distance from an obstruction is measured by four ultrasonic sensors in the rear bumper panel and four additional ultrasonic sensors in the front bumper panel (positions 11 and 19).
- Two additional ultrasonic sensors are installed in the rear bumper to precisely detect the size of a transverse parking space during the parking maneuver. The additional ultrasonic sensors measure the distance to detected objects.

G12 Driver Assistance Systems

18. Parking Maneuver Assistant

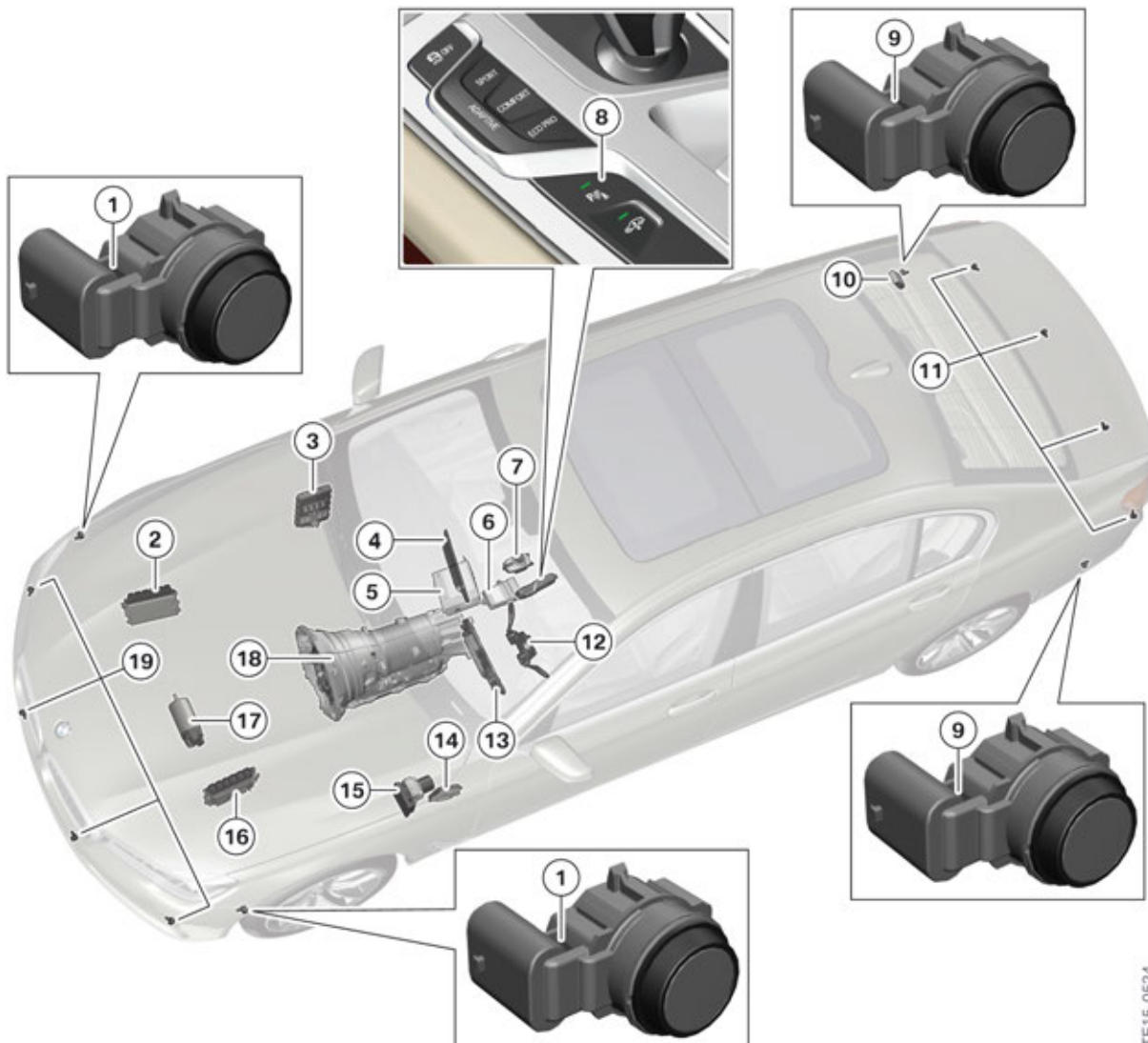

TE15-0524

G12 Parking Maneuver Assistant system components

Index	Explanation
1	Ultrasonic sensors of Parking Maneuver Assistant
2	Digital Motor Electronics (DME)
3	Body Domain Controller (BDC)
4	Central information display CID
5	Head Unit High 2 (HU-H2)
6	Advanced Crash Safety Module (ACSM)
7	Controller (CON)
8	Parking assistance button
9	Ultrasonic sensors, Park Distance Control, rear side
10	Control unit for Parking Maneuver Assistant (PMA)

G12 Driver Assistance Systems

18. Parking Maneuver Assistant

Index	Explanation
11	Ultrasonic sensors, Park Distance Control, rear
12	Steering column switch cluster (SZL)
13	Instrument panel (KOMBI)
14	Control unit for optional equipment system (SAS)
15	Dynamic Stability Control (DSC)
16	Digital Engine Electronics 2 (DME2)
17	Electronic Power Steering (EPS)
18	Electronic transmission control (EGS)
19	Ultrasonic sensors for Park Distance Control, front

18.2. System wiring diagram

The system wiring diagram on the next page shows an overview of the system components used when parking and maneuvering the vehicle. Depending on the vehicle equipment, partial scopes of supply may also be installed.

G12 Driver Assistance Systems

18. Parking Maneuver Assistant

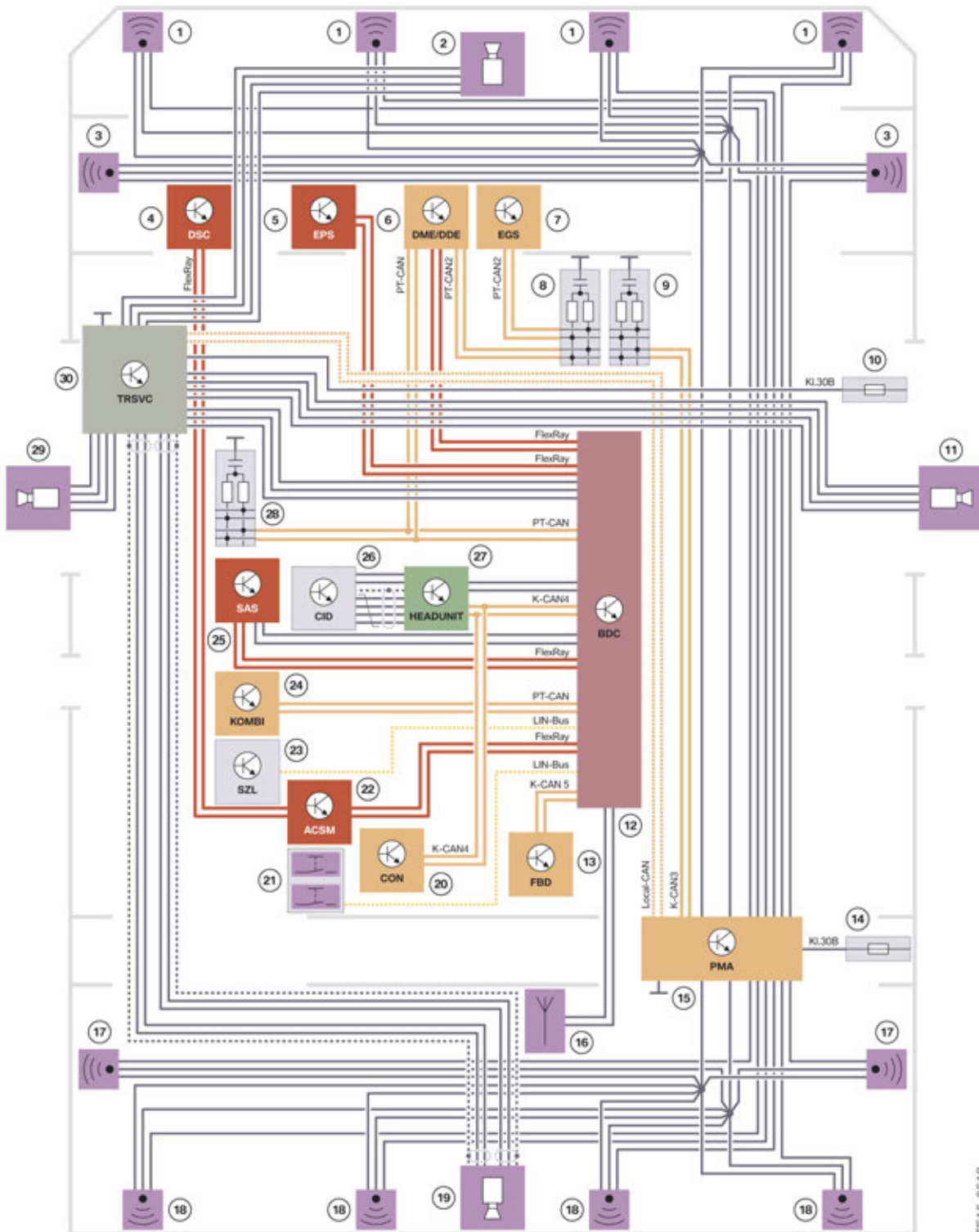

TE15-0518

G12 parking and maneuvering system wiring diagram

G12 Driver Assistance Systems

18. Parking Maneuver Assistant

Index	Explanation
1	Ultrasonic sensors for Park Distance Control, front
2	Front camera
3	Ultrasonic sensors for Parking Maneuver Assistant
4	Dynamic Stability Control (DSC)
5	Electronic Power Steering EPS
6	Digital Motor Electronics (DME)/
7	Electronic transmission control EGS
8	CAN terminator
9	CAN terminator
10	Fuse for front right power distribution box
11	Right side view camera
12	Body Domain Controller (BDC)
13	Remote control receiver (FBD)
14	Fuse for rear right power distribution box
15	Control unit for Parking Maneuver Assistant (PMA)
16	Remote Control Parking antenna
17	Ultrasonic sensors, Park Distance Control, rear side
18	Ultrasonic sensors, Park Distance Control, rear
19	Rear view camera (RFK)
20	Controller (CON)
21	Parking assistance button and button for camera activation
22	Advanced Crash Safety Module (ACSM)
23	Steering column switch cluster (SZL)
24	Instrument panel KOMBI
25	Control unit for optional equipment system (SAS)
26	Central information display (CID)
27	Head Unit High 2 (HU-H2)
28	CAN terminator
29	Left side view camera
30	Top rear side view camera (TRSVC) control unit

G12 Driver Assistance Systems

18. Parking Maneuver Assistant

18.3. Control unit

In vehicles with the Parking Maneuver Assistant optional equipment (OE 5DP), the Park Distance Control and Parking Maneuver Assistant functions are provided by the PMA control unit.



G12 control unit for Parking Maneuver Assistant (PMA)

18.4. Functional principle

The Parking Maneuver Assistant function facilitates maneuvering into parking spaces that are parallel (parallel parking) and perpendicular (bay parking) to the roadway. The system measures potential parking spaces when driving past at a speed below approximately 35 km/h without the system having been activated.

The parking spaces are measured by two additional ultrasonic sensors, which are integrated into the front wheel arch. These two sensors are connected to the Parking Maneuver Assistant (PMA) control unit, which also incorporates the Park Distance Control function. The function of the two ultrasonic sensors is similar to that of the Park Distance Control PDC. Ultrasonic pulses are sent and echo impulses are received.

Two additional ultrasonic sensors are installed in the rear bumper of the G12 to precisely detect the size of a transverse parking space during the parking maneuver. The additional ultrasonic sensors measure the distance to detected objects.

If a parking space of a sufficient length and width is found and the system is activated, the driver is shown the space on the central information display.

The Parking Maneuver Assistant function then takes over the vehicle handling entirely, including steering, braking and gear selection.

Spaces that do not have a vehicle at either side are also recognized as suitable parking spaces. This makes it possible to park behind only one object.

The driver is still responsible for monitoring the vehicle environment and can intervene in the automatic parking maneuver at any time if required due to the vehicle environment. When searching for a parking space and when parking, all relevant information is presented to the driver in an integrated display; from the parking space itself to the status of the parking assistant and corresponding handling instructions through to distances from other objects.

G12 Driver Assistance Systems

18. Parking Maneuver Assistant

Personal responsibility:

- Directly monitor gaps and the parking procedure and intervene if necessary, as otherwise there is a risk of accidents.
- If a parking space that has already been measured changes, the system does not take this into account.
- The system does not take loads that project above the vehicle into account during parking.
- The Parking Maneuver Assistant PMA may steer the vehicle over or up onto curbs. You should therefore use the facility for active intervention at any time with caution as you may otherwise damage wheels and tires or the vehicle itself.



The Parking Maneuver Assistant PMA does not relieve the driver of personal responsibility during parking. Therefore, be attentive in order to be able to actively intervene at any time. Otherwise, there is a risk of an accident.

18.5. Functional prerequisites

To use the Parking Maneuver Assistant function, the following basic prerequisites must be met:

- the doors must be closed
- the tailgate must be closed
- the driver's seat belt must be fastened
- the parking brake must be released

18.5.1. Measuring parking spaces

Parking spaces are measured while driving. The following parameters apply:

- Driving forwards straight-ahead up to about 35 km/h
- Maximum distance to the row of parked vehicles: 1.5 m.

Detecting the curb

If a curb is detected within the range of the ultrasonic sensor while the system is searching for a parking space, the parking space is for the most a space that is parallel to the road.

In the case of parking spaces that are perpendicular to the roadway, the curb is usually outside the detection range of the ultrasonic sensors (range about 4.2 m).

G12 Driver Assistance Systems

18. Parking Maneuver Assistant

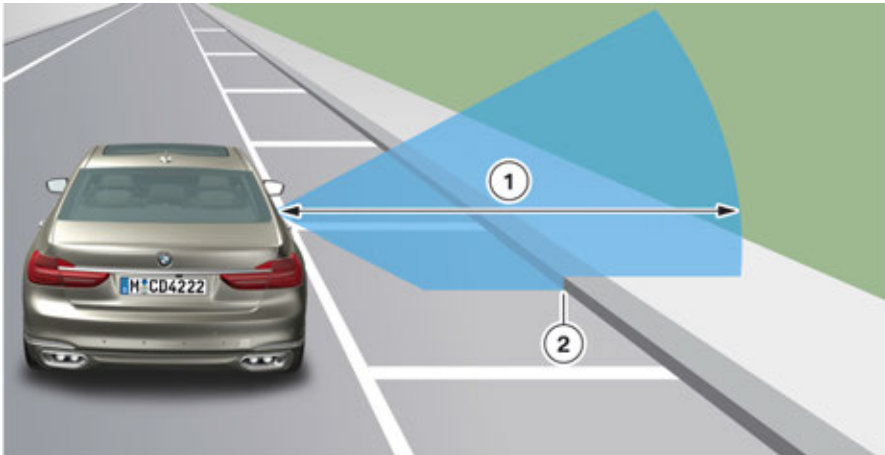

G12 curb detection via the ultrasonic sensors

Index	Explanation
1	Range about 4.2 m; opening angle of ultrasonic sensors vertical $\pm 30^\circ$
2	Kerb detection

18.5.2. Suitable parking spaces parallel to the roadway (parallel parking)

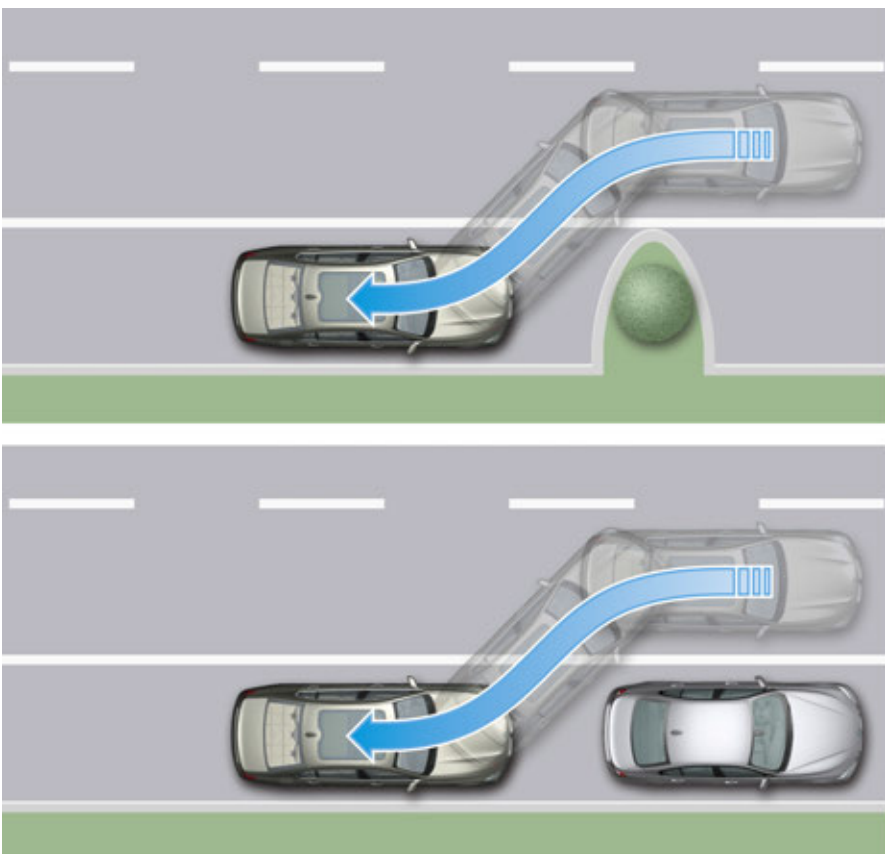

G12 principle of parallel parking

G12 Driver Assistance Systems

18. Parking Maneuver Assistant

Size of parking space	vehicle length plus about 0,8 m
Length of objects	at least 0.5 m
Minimum number of detected objects	1
Minimum depth of parking space	about 1,5 m

The minimum length of an object detected by the vehicle must be approximately 0.5 m. With an object length of 0.5 m, a curb must still be detected by the PMA sensors for the purpose of parking in a parallel (curbside) parking space so as to ensure that the parking space is a parallel one.

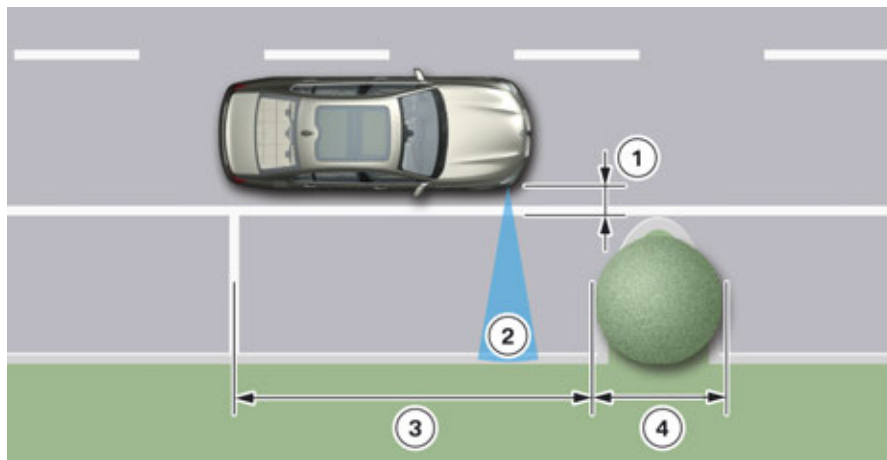

G12 requirements of parallel parking spaces

Index	Explanation
1	Maximum distance to the row of parked vehicles or objects: 1.5 m
2	Opening angle of the ultrasonic sensor horizontal: $\pm 40^\circ$, range about 4.2 m
3	Length of the parking space: vehicle length plus about 0,8 m
4	Object or vehicle length at least 0.5 m

G12 Driver Assistance Systems

18. Parking Maneuver Assistant

18.5.3. Suitable parking spaces perpendicular to the roadway (bay parking)

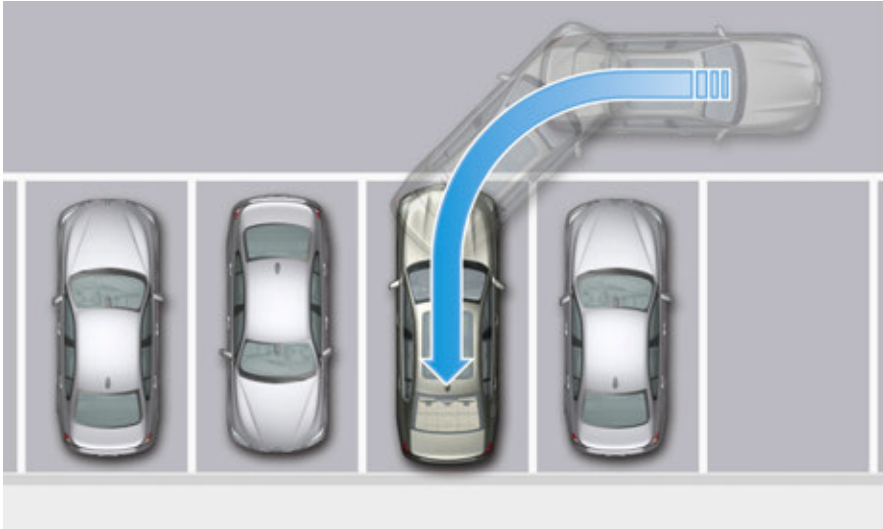

G12 principle of bay parking



The depth of perpendicular (cross) parking spaces must be gauged by the driver himself. Due to technical limits the system can only approximately determine the depth of perpendicular (cross) parking spaces.

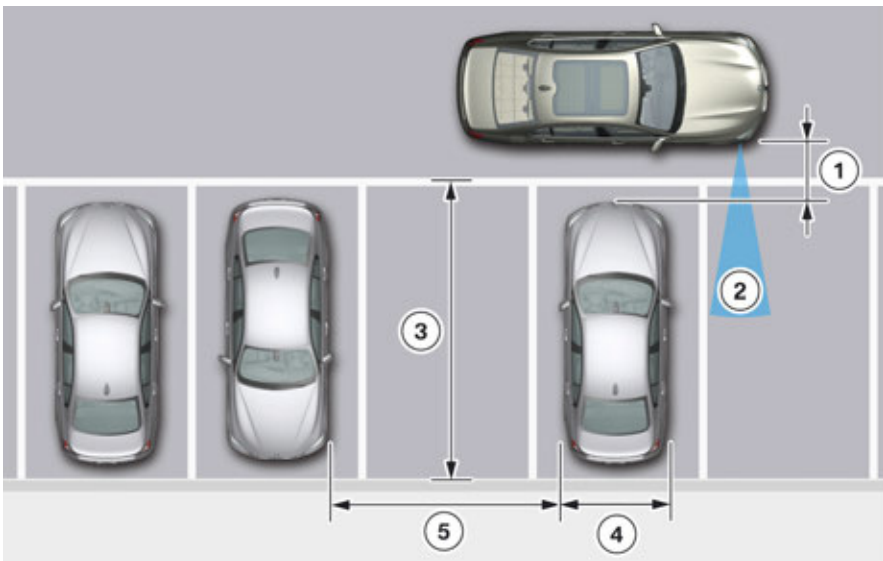

G12 requirements of bay parking spaces

G12 Driver Assistance Systems

18. Parking Maneuver Assistant

Index	Explanation
1	Maximum distance to the row of parked vehicles: 1.5 m
2	Opening angle of the ultrasonic sensor horizontal: $\pm 40^\circ$, range about 4.2 m
3	Minimum depth of the parking space: own vehicle length
4	Vehicle or object width at least 0.5 m
5	Width of the parking space: vehicle width plus about 0.7 m up to max. 5 m

G12 Driver Assistance Systems

18. Parking Maneuver Assistant

Different bay parking spaces

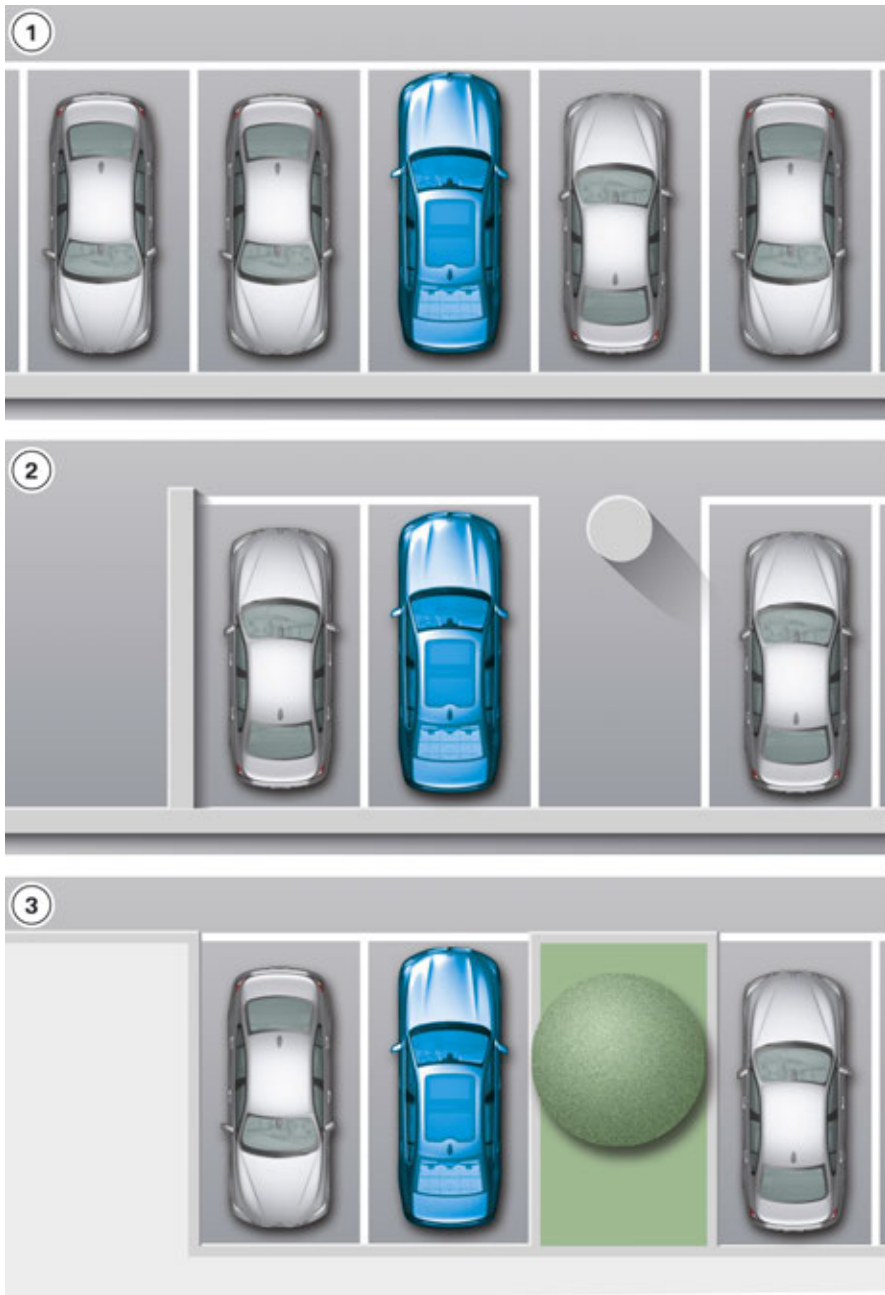

G12 bay parking spaces

Index	Explanation
1	Standard parking space between two passenger cars
2	Parking space with post (underground car park)
3	Parking space with obstacles (public car park)

G12 Driver Assistance Systems

18. Parking Maneuver Assistant

18.5.4. Detection of a universal parking space

Due to the technical system limits, the vehicle does not always detect the correct parking space. Situations may occur where parking spaces are wrongly detected, or parking spaces that are unsuitable or not actually classed as parking spaces are detected.

The below graphic shows a situation where this may be the case.

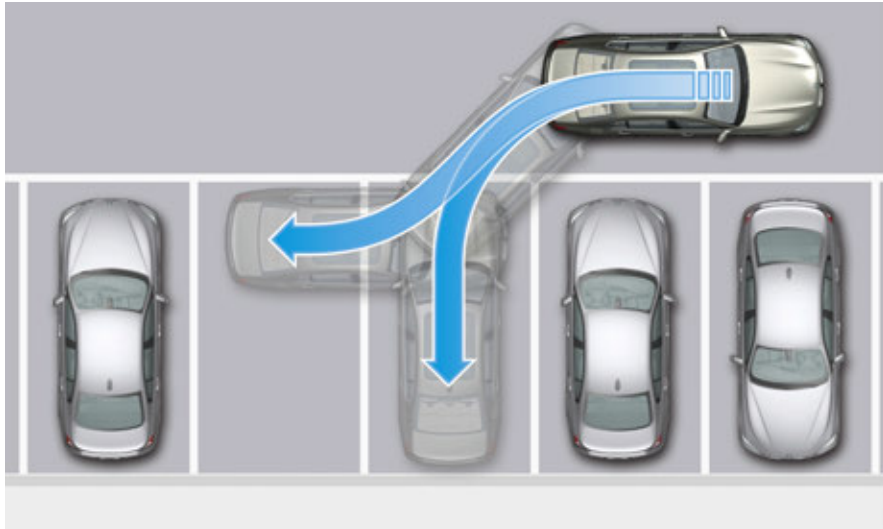

G12 detection of a universal parking space

The detected parking space is big enough to park the vehicle in both perpendicularly and parallel to the roadway. Because of the **absence** of a curb, the vehicle cannot correctly determine the parking space. The vehicle proposes a universal parking space. In this case, the driver must decide how he wants to maneuver into the parking space.

The following display appears on the central information display when the vehicle has detected a universal parking space.

G12 Driver Assistance Systems

18. Parking Maneuver Assistant



G12 universal parking space display on the CID

18.6. Side protection

The side protection warns against obstacles at the side of the vehicle and thus supports the driver when parking and maneuvering.

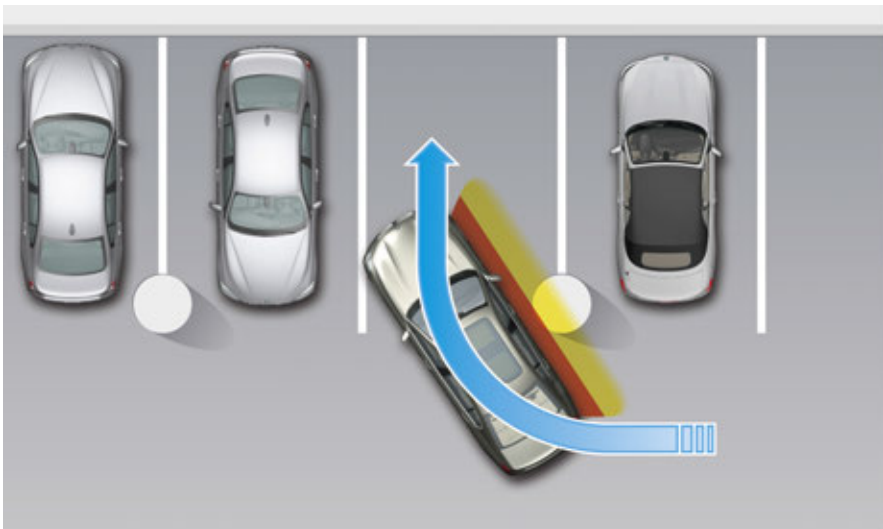

G12 side protection

Four side ultrasonic sensors, two integrated in the front bumper and two integrated in the rear bumper, measure the distance to an obstruction. Obstructions detected by the sensors are tracked along the side of the vehicle as it moves. They are shown on the central information display and, in situations where a collision is imminent, an acoustic warning also sounds.

G12 Driver Assistance Systems

18. Parking Maneuver Assistant



G12 side protection view on the CID

Obstructions approaching the stationary vehicle are not taken into account, as in this case the system cannot evaluate the situation unequivocally. The prerequisite for identifying obstructions is that the (driver's) vehicle is moving.

The distance markings shown on the central information display are displayed for approximately 13 seconds once the vehicle has stopped. The markings are only shown again once the vehicle starts moving.

18.7. Operation

There are two ways to activate the Parking Maneuver Assistant function:

- Activation via parking assistance button
- Activation by "Engaging reverse gear" followed by "iDrive controller operation"

Activation via parking assistance button

When the PMA is activated via the parking assistance button in the center console the parking assistance menu in the Central Information Display CID is displayed. As soon as a parking space is found, the driver receives handling instructions that guide him through the parking procedure with the support of the system. When parking automatically, the driver must hold down the parking assistance button until the parking procedure is complete.

G12 Driver Assistance Systems

18. Parking Maneuver Assistant



G12 switch block with parking assistance button

Index	Explanation
1	Parking assistance button

Activation by "Engaging reverse gear" followed by "iDrive controller operation"

When reverse gear is engaged, the Parking Maneuver Assistant menu is displayed on the central information display accompanied by the status of the parking space search. The Parking Maneuver Assistant (PMA) is however not yet activated. This is indicated to the driver by the Parking Maneuver Assistant symbol in the toolbar of the central information display. In order to park supported by the system, the parking operation must be activated via the controller by selecting the corresponding symbol in the symbol bar at the Central Information Display (CID). When parking automatically, the driver must hold down the parking assistance button until the parking procedure is complete.

18.7.1. Parking procedure (parallel parking)

A check mark then appears on the right below the Parking Maneuver Assistant symbol on the central information display to tell the driver that Parking Maneuver Assistant is active.

If the Parking Maneuver Assistant function is activated during the journey using the parking assistance button, the driver is informed about the parking space search on the CID. When a parking space is found, it appears on the corresponding page on the central information display. The driver is also instructed to stop the vehicle at the same time.

G12 Driver Assistance Systems

18. Parking Maneuver Assistant



G12 parking procedure using PMA (parallel parking)

The driver is instructed to confirm the parking space by using the turn indicator corresponding to the parking direction.



G12 parking procedure using PMA (parallel parking)

The parking procedure can now be started by pressing the parking assistance button. The parking assistance button must be held down. Then the driver must release the brake.



G12 parking procedure using PMA (parallel parking)

The button must be held down continuously until the parking procedure is complete.

G12 Driver Assistance Systems

18. Parking Maneuver Assistant

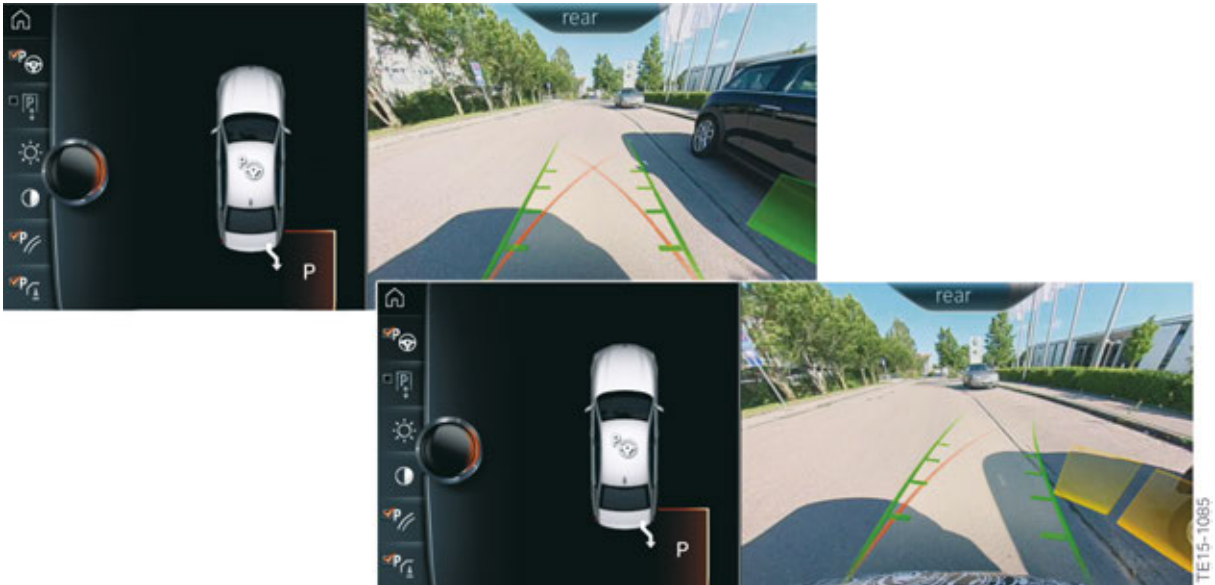

G12 parking procedure using PMA (parallel parking)

Upon completion, an acoustic signal sounds and a confirmation message appears to tell the driver that the parking procedure is complete. The Parking Maneuver Assistant engages "P" thus preventing the vehicle from rolling away.



G12 parking procedure using PMA (parallel parking)

18.7.2. Parking procedure (bay parking)

The following graphics show the bay parking process.

G12 Driver Assistance Systems

18. Parking Maneuver Assistant



G12 parking procedure using PMA (bay parking)

G12 Driver Assistance Systems

18. Parking Maneuver Assistant

18.7.3. Deactivation criteria

Manual deactivation criteria

The Parking Maneuver Assistant PMA can be deactivated at any time if necessary by the driver via the controller by selecting the corresponding symbol in the symbol bar on the Central Information Display CID. Another way to deactivate the Parking Maneuver Assistant PMA is to release the parking assistance button in the switch block next to the iDrive controller.

If a fault develops, a Check Control message ("The PDC has malfunctioned. Have system checked.") is displayed in the Central Information Display CID.

Automatic deactivation criteria

The Parking Maneuver Assistant PMA is switched off automatically when the following events occur:

- the parking assistance button is released
- the driver holds on to the steering wheel or steers himself
- a gear is selected that does not correspond to the instruction on the control display
- when accelerating
- the parking brake is secured
- the turn indicator opposite the required parking side is switched on
- at speeds above about 10 km/h
- possibly if the roadway is covered with snow or is slippery
- the tailgate is open
- possibly if the objects are difficult to overcome, e.g. curbs
- if obstructions suddenly appear
- a maximum number of parking maneuvers or the parking duration has been exceeded.

18.8. Limits of the system

The detection of objects can test the ultrasonic measurement system to its limits. Several examples of this are shown below:

- with trailer towbars and couplings
- if the objects are thin or wedge-shaped
- if the objects are projecting and elevated, e.g. wall projections or loads
- if the objects have corners and sharp edges
- if the objects have fine surfaces or structures, e.g. fences.

Low objects that are already displayed, e.g. curbs, may fall within the blind spot of the sensors before or after a continuous alarm sounds. It would not be possible to detect objects that are higher up and projecting, e.g. wall projections. Parking spaces may be detected although these are not suitable.

G12 Driver Assistance Systems

18. Parking Maneuver Assistant

There may be other functional limitations in the following situations, for example:

- if the sensors are soiled or iced up
- in heavy fog, rain or snow
- on uneven surfaces, e.g. gravel roads
- on slippery surfaces
- on steep inclines or downhill gradients
- if leaves have gathered or snow has piled up in the parking space.

To ensure the ultrasonic sensors remain fully operational, they must be kept clean and free of ice. When cleaning the sensors using a high pressure cleaner, avoid direct and sustained contact with a high-pressure water jet. Furthermore, when using high pressure cleaners, a distance of at least 30 cm from the sensors must be maintained.



The Parking Maneuver Assistant PMA cannot replace the driver's personal judgement of the traffic situation. Also check the traffic situation around the vehicle by looking around, otherwise there may be a risk of an accident as a result of road users or objects which lie outside the detection range of the Park Distance Control. Loud sound sources outside and inside the vehicle may mask the acoustic signals of the Parking Maneuver Assistant PMA or the Park Distance Control PDC.

G12 Driver Assistance Systems

19. Cruise Control

19.1. Introduction

Two cruise control functions can be used in the G12. The cruise control with braking function (DCC) is part of the basic equipment.

The customer also has the option of ordering the Active Cruise Control with Stop&Go function (ACC Stop&Go) optional equipment (OE ZN7) part of ZDT Driver Assistance Plus II.

ACC Stop&Go can also be obtained if the customer opts for the Active Driving Assistant Plus optional equipment (OE 5AT), as it is contained in this equipment package.

Other features of the Active Driving Assistant Plus optional equipment (OE 5AT) are the steering and lane control assistant and the traffic jam assistant. When used in conjunction with the steering and lane control assistant and the traffic jam assistant, ACC Stop & Go provides optimum support for the driver.



The cruise control systems support the driver with adapting the speed, distance and driving style to the traffic conditions, but do not relieve him of his responsibility. The driver must actively intervene, e.g. by braking, steering or taking evasive action, as otherwise there is a risk of an accident.

19.2. Cruise control with braking function

The cruise control with braking function is included as part of the G12's basic equipment. The system is also known as "Dynamic Cruise Control" (DCC). Dynamic Cruise Control (DCC) supports the driver on roads with less traffic by keeping the speed constant irrespective of rolling resistances (incline, downhill driving and vehicle load). In spite of the support, the driver remains responsible for control of the vehicle. It is possible to override the DCC function at any time by braking or accelerating the vehicle.

19.2.1. Control functions

Cruise control

The cruise control calculates a target acceleration or deceleration based on the speed set by the driver and the actual speed.

Acceleration and deceleration

The driver can specify the set speed or acceleration via the rocker switch on the multifunction steering wheel (MFL).

Cruise control on bends

Another purpose of this function, also referred to as the "lateral acceleration controller", is to prevent the lateral acceleration from increasing above an acceptable level when cornering with the cruise control switched on. A lateral acceleration is calculated from the driving speed and yaw rate. This value is compared with a speed-dependent limit in order to achieve the following seemingly contradictory objectives:

G12 Driver Assistance Systems

19. Cruise Control

- Disruptive and overly restrictive interventions are avoided if the driver himself would also prefer high lateral acceleration.
- Useful interventions and therefore also significant limitations in dynamics are effected at high speeds. Most drivers find an overly high lateral acceleration in these situations unpleasant, which is why a lower limit value is used.

The output variable for the cornering cruise control is also used as a set-point value for the longitudinal acceleration.

Prioritization of the partial set-point value

The set-point value with the highest priority according to the situation is selected from the longitudinal acceleration set-point values for the control functions referred to above. Signals are filtered to prevent abrupt jumps when adjusting the set-point values.

Estimation of disturbance force

An acceleration or brake force must be calculated in order to be able to apply the prioritized longitudinal acceleration with the assistance of the actuators. Example: more driving power is required to achieve the same longitudinal acceleration during an uphill journey than on the flat. If the vehicle needs to decelerate when travelling up hill, less braking force is required compared to driving on the flat. In order to be able to correctly calculate the forces required, the precise value of the gradient and also the weight of the vehicle, the rolling resistance, the drag and other acceleration forces must be known. As a sensor system that can monitor all of these disturbances does not exist, an estimated value is calculated instead by comparing the following two variables:

- actual movement variables of the vehicle
- anticipated movement variables of the vehicle as a result of the driving power and braking forces currently acting on the vehicle.

The extent of the disturbing force determined using this method is taken into account during subsequent processing of the longitudinal acceleration setpoint value by means of addition or subtraction.

19.2.2. Activation of the actuators

Driving power and/or braking forces must be introduced in order to produce the longitudinal acceleration calculated by the control functions and thus compensate for disturbing forces acting on the vehicle. To accelerate the vehicle, a setpoint value for the drive is usually transmitted. In exceptional cases during downhill driving on a steep gradient, it may be necessary to activate the brake to ensure the acceleration does not exceed a specific value.

If the vehicle needs to be decelerated, the extent of the contribution that may be required by the drive towards the deceleration, and therefore the braking effect of the engine and transmission, is initially determined. This value is output to the Digital Motor Electronics (DME) or and electronic transmission control (EGS). If this value cannot be achieved by the drivetrain alone, the additional amount required is transmitted to the Dynamic Stability Control (DSC).

The vehicle's brake lights are also switched on if the brakes are noticeably actuated in order to produce the desired deceleration.

G12 Driver Assistance Systems

19. Cruise Control

19.2.3. Operation

The driver has the option of adjusting the set speed in small or large increments, which is then set and maintained by the system by controlling the drive and brakes. It can be changed using the left-hand switch block on the multifunction steering wheel (MFL). The speed is increased or reduced by 1 km/h by tapping the rocker switch. Each time the rocker button is pressed beyond the pressure point, the speed increases or reduces by 10 km/h. The DCC steadily maintains a selected speed from about 30 km/h.

The set speed is indicated in the instrument cluster KOMBI in the familiar way; by a mark that moves round the speed reading. Notes are added to the displays in the instrument cluster if necessary.

If the vehicle's own deceleration is not sufficient to maintain the preset speed, the brake is activated accordingly.

The adjustment range for the set speed is limited to a maximum of 210 km/h.

If ECO PRO or SPORT mode is activated, the cruise control is also set to a fuel-efficient or sporty driving style. Due to the fuel-efficient driving style in ECO PRO driving mode, in some situations the vehicle's speed may exceed or drop below the set speed, for example on downhill gradients or inclines.



G12 Dynamic Cruise Control (DCC) buttons

Index	Explanation
1	Button for activating or deactivating the Dynamic Cruise Control DCC
2	Rocker switch for changing the set speed
3	“SET” button for setting the speed of cruise control
4	Button for calling up a saved set speed/temporarily switching off the cruise control

G12 Driver Assistance Systems

19. Cruise Control

The system is interrupted automatically in the following situations:

- If the brakes are used
- If the selector lever position is moved out of position "D"
- If the Dynamic Traction Control (DTC) is activated or the Dynamic Stability Control (DSC) is deactivated
- If the Dynamic Stability Control (DSC) is performing an adjustment

19.3. Active cruise control with Stop&Go function

The active cruise control with Stop&Go function, ACC Stop&Go (OE 5DF) is offered as optional equipment for the G12 as part of the ZDB Driver Assistance Plus II (5AT) package.

ACC Stop&Go adjusts a driver-specified set speed and, if required by the traffic situation, also automatically adjusts the preselected following distance to the vehicle driving ahead (detected vehicles include passenger cars, trucks and motorbikes). The application range of ACC Stop&Go ranges from higher speeds down to a standstill. The distance and the speed are automatically adjusted in this range.

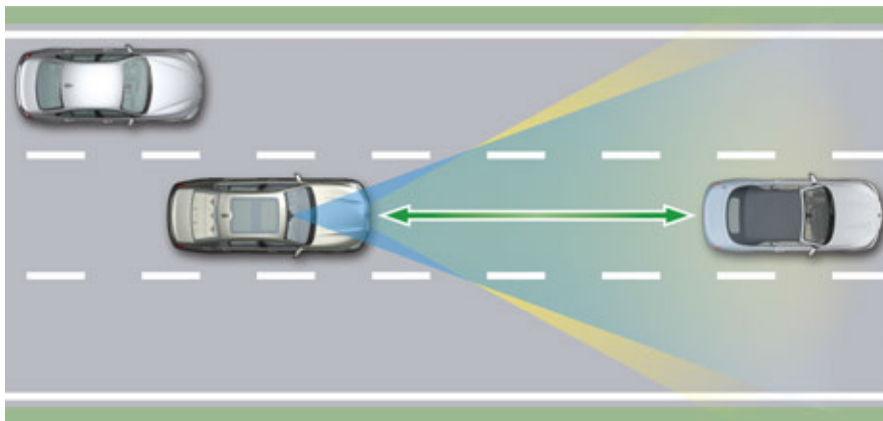

G12 Active Cruise Control

Depending on the stationary time, driving off from a standstill is performed automatically or in response to a prompt by the driver. ACC Stop&Go not only detects vehicles that are slowly coming to a halt, but also stationary vehicles.

Due to improved monitoring in front of the vehicle, the system is capable of reacting more quickly to vehicles swinging in and out and turning off.

The extended application range has been achieved by the incorporation of the KAFAS stereo camera. Image data is evaluated by the ACC Stop&Go system. The KAFAS control unit clearly detects vehicles when their rear ends are recorded by the camera. In addition, the KAFAS control unit ensures that the driving lane information, vehicle positions and movements are determined.

In addition to image data, radar data is also gathered and evaluated by the radar sensors. This fusion of image and radar data makes possible the clear identification of lane markings and the distinction between stationary vehicles and other fixed objects.

G12 Driver Assistance Systems

19. Cruise Control

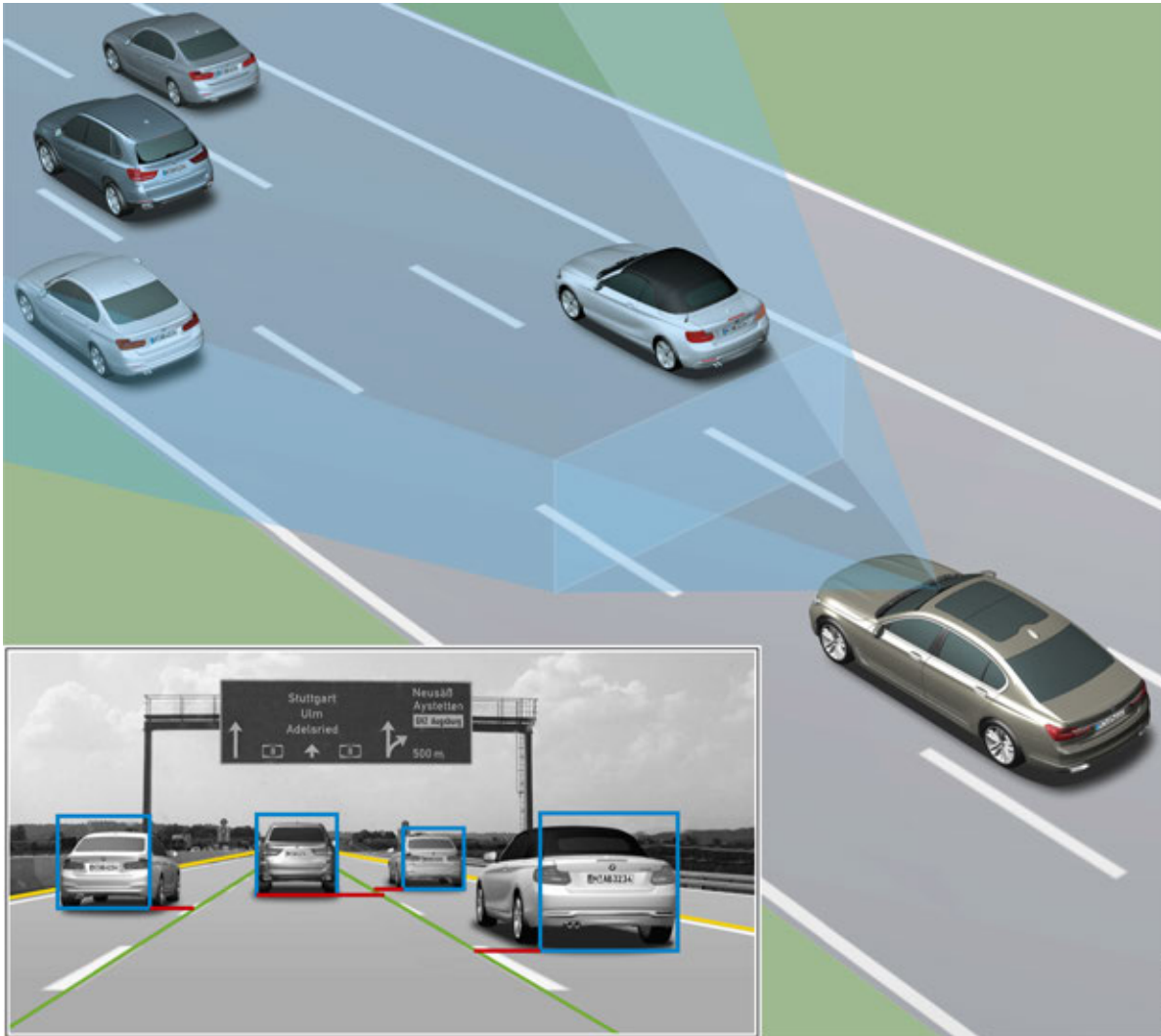

Object detection provided by a combination of radar sensor and KAFAS stereo camera

A 77 GHz radar sensor emits bundled electromagnetic waves. The echoes reflected by objects are received and evaluated by the radar sensor. This enables information about objects located in front of the radar sensor to be obtained. This information includes size, distance and the deduced speed. The radar sensor of the system can identify vehicles ahead up to a distance of 200 m, to a large extent irrespective of weather conditions.

The sensor is located behind the air inlet grille on the front bumper.

G12 Driver Assistance Systems

19. Cruise Control



G12 installation location of front radar sensor for ACC Stop&Go

Index	Explanation
1	Sensor for ACC Stop & Go
2	Removable grille

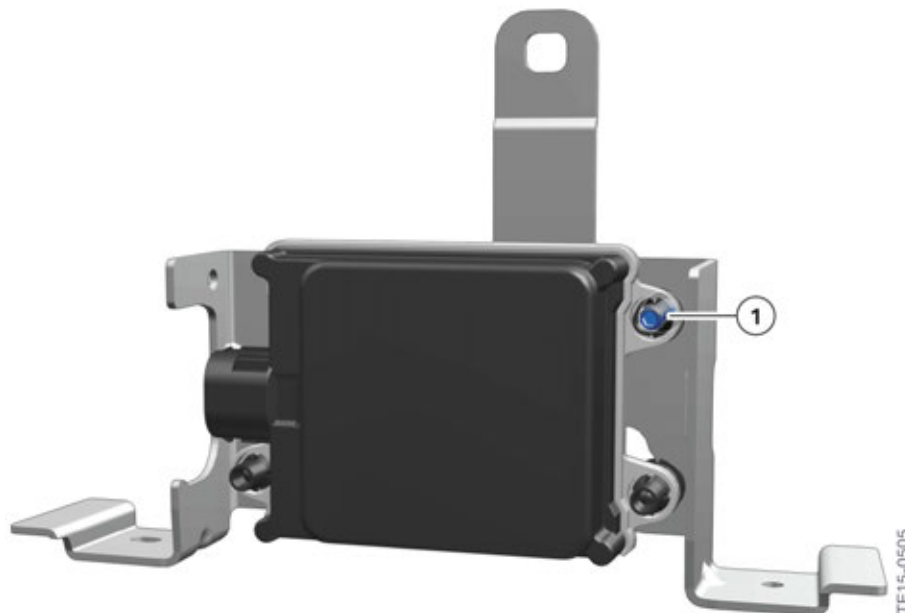

G12 front radar sensor for ACC Stop&Go

Index	Explanation
1	Adjustment feature

G12 Driver Assistance Systems

19. Cruise Control

Thanks to the radar sensor's improved detection capability and alignment with the image data from the KAFAS stereo camera, vehicles in neighboring lanes are also detected. If these vehicles are driving in their own lane, then ACC Stop&Go adapts the speed to the vehicle pulling in or vehicle ahead. As a result, a time lag selected by the driver is constantly maintained.

ACC Stop&Go adjusts the speed if there is no vehicle driving directly ahead and automatically switches to distance control if the sensor system detects a slower vehicle in its lane. The system's Stop & Go function brings the vehicle to a complete standstill if necessary.



If the vehicle ahead drives off again after a standstill, the driver is informed thereof with a note. To drive off again, the driver must acknowledge this information by pressing the RES/CNCL button or the accelerator pedal. Only if the duration of the standstill is very short (about 3 seconds) is the starting process effected fully automatically by ACC Stop&Go.

In this way, ACC Stop & Go supports the driver not only in flowing traffic, but also in traffic jam situations, both on multiple-lane highways and ordinary roads and on urban arterial and ring roads.

The adjustment range for the set speed is limited to a maximum of 210 km/h.

If ECO PRO or SPORT mode is activated, the Active Cruise Control with Stop&Go function is also set to a fuel-efficient or sporty driving style. Due to the fuel-efficient driving style in ECO PRO driving mode, in some situations the vehicle's speed may exceed or drop below the set speed, for example on downhill gradients or inclines.

19.3.1. Control functions

The calculations are performed in the optional equipment control unit SAS.

Cruise control

In principle, the cruise control in the ACC Stop&Go system works in exactly the same way as the Dynamic Cruise Control (DCC) system.

Cruise control on bends

The cruise control of the ACC Stop&Go on bends is based on the control characteristics of the Dynamic Cruise Control (DCC). If an object is lost on bends, the system waits to see whether the object reappears (transition curve). The vehicle only accelerates if it does not reappear or the sensor system no longer detects an object. Tight bends are detected via the data of the Dynamic Stability Control system DSC and the navigation system and the speed adjusted if necessary.

Distance control (ranging)

The distance control is the core function of the ACC Stop&Go system.

The driver can select a desired distance in four stages using the multifunction button on the multifunction steering wheel (MFL). From this preselection ACC Stop&Go calculates the reference distance to the vehicle driving ahead for the control. In vehicles with the Active Cruise Control optional

G12 Driver Assistance Systems

19. Cruise Control

equipment (OE 5DF), the distance is adjusted using two buttons; one to reduce and one to increase the distance. In vehicles with the Driving Assistant Plus optional equipment (OE 5AT), the distance is adjusted using the rocker button.

ACC Stop&Go calculates the reference distance for the control from this preselection. The following distance most recently selected is saved depending on the key being used.

The reference distance during the journey is proportional to the driving speed. At a lower driving speed and at standstill, the proportional distance to the driving speed is no longer used for the ACC Stop & Go, but a fixed value in metres.

If a vehicle moves into the driver's lane, which is anticipated due to the current driving condition, or if the driver is approaching a vehicle driving ahead, the ACC Stop&Go function discretely adapts the speed to the vehicle pulling in or vehicle ahead.

The distance control uses the prepared object data with the highest diagnostic statistic as input variables. The distance control takes into consideration the following situations in particular:

- **Maximum values for acceleration and deceleration:**
The maximum values for acceleration and deceleration of the ACC Stop&Go system below about 50 km/h are dynamic values. They correspond to the acceleration and deceleration values that the driver would use himself and considers comfortable. In situations where sharper deceleration is required than the system offers as part of the speed adjustment feature, a visual and acoustic signal is issued to the driver to inform him to take over vehicle handling.
Depending on the situation, the ACC Stop & Go accelerates by a maximum of about 2 m/s² and decelerates by a maximum of about 4 m/s².
- **Stop and start stability:**
In the case of very heavy traffic and very low driving speed, the risk of rear-end collisions increases through heavy acceleration and braking. The ACC Stop&Go distance controller is therefore designed to decelerate as early as possible, but not more than the vehicle ahead. The system can decelerate by up to 2.5 m/s² at the most during subsequent operation, and by up to 4 m/s² at the most when stopping.

Request to take over vehicle handling

When ACC Stop&Go is no longer able to maintain a safe distance or a critical situation is detected, e.g. on account of very high differential speeds or an insufficient maximum deceleration, two short warning signals sound and the orange lit up vehicle symbol in the instrument cluster or the Head-Up Display (optional equipment OE 610) flashes. The system continues to perform its control function and prompts the driver to take over vehicle handling and to keep their distance accordingly.

19.3.2. Operation

Activation and deactivation

The activation and deactivation of the ACC Stop & Go and the Dynamic Cruise Control are almost the same. ACC Stop&Go can either be activated while driving or at a standstill. For safety reasons, when the vehicle is at a standstill the function can only be put in Standby mode or deactivated while the footbrake is applied.

G12 Driver Assistance Systems

19. Cruise Control

If the function is active, it can be interrupted by pressing the RES/CNCL button. The distance and speed will no longer be maintained and the set speed is greyed out in the instrument cluster.

The driver can select a desired distance in four stages using the left-hand multifunction button on the multifunction steering wheel (MFL). The last selected following distance is saved depending on the key being used.

- The following graphic shows the button assignment for the assistance systems on the multifunction steering wheel (MFL) in vehicles **with** the Active lane keeping assistant including traffic jam assistant:



G12 buttons for ACC Stop&Go with Active Driving Assistant Plus II optional equipment (OE 5AT)

Index	Explanation
1	Button for activating or deactivating the lane keeping assistant including traffic jam assistant
2	Button for activating or deactivating ACC Stop & Go
3	Rocker switch for changing the set speed
4	“SET” button for setting the speed of cruise control
5	Button for adjusting the distance of the driver's vehicle to the vehicle driving ahead
6	Button for calling up a saved set speed/temporarily switching off the cruise control

The following conditions must also be satisfied for activation:

- Seat belt fastened and doors closed
- Drive position "D" engaged and brake pressed
- Engine running
- Parking brake not activated
- Camera and radar sensor operational
- No system faults detected.

G12 Driver Assistance Systems

19. Cruise Control

The system is interrupted automatically in the following situations:

- If the brakes are used
- If the selector lever position is moved out of position "D"
- If the Dynamic Traction Control (DTC) is activated or the Dynamic Stability Control (DSC) is deactivated
- If the Dynamic Stability Control (DSC) is performing an adjustment
- If the seat belt is unfastened and the driver's door is opened in a stationary vehicle
- If the system has not detected an object for a long time, e.g. on rarely frequented sections of road with no distinct edge
- If the detection range of the radar is impaired, e.g. due to contamination or heavy precipitation
- Following a longer immobilization period, if the vehicle has been decelerated to a standstill by ACC Stop&Go.

The set speed is indicated in the instrument cluster in the familiar way; by a mark that moves round the speed reading. If ACC Stop&Go is activated, this mark is green, whereas in "Standby" mode it is grey and the last set speed is displayed. After the ACC Stop&Go function is activated or after the driver has adjusted the set speed, the current digital value is displayed. If the distance is changed, a symbol appears briefly as an acknowledgement. The symbol screen masks are for example the set speed and the distance bar. With each subsequent operation the display is shown for another three seconds.

The distances set by the driver, as well as the distances to any vehicles driving ahead, that must be maintained to ensure a safe distance are displayed between the two round instruments (speed reading and engine speed display). The distance setting is stored for the ID transmitter currently being used. Like for DCC, it is also necessary that the symbol screen masks are complemented if necessary with notes in the instrument cluster for ACC Stop & Go.

With active control the displays are also shown in the Head-Up Display (optional equipment OE 610).

If the system can no longer adjust a safe distance, for example due to very high differential speeds, then the driver is prompted to take over the vehicle handling by a flashing red vehicle symbol and an acoustic signal.





Display



Displays in the instrument cluster when ACC Stop&Go is activated



G12 Driver Assistance Systems

19. Cruise Control

Symbols	Explanation
 TE15-0971	Display lights up black/grey, no vehicle symbol shown: System has been interrupted.
 TE15-1033	Distance control briefly paused, as the accelerator pedal is pressed.
 TE15-0972	Vehicle symbol and distance bars flash red and a signal sounds: Request for intervention by braking and, if required, evasive action.
 TE15-0973	Distance control (ranging) active: ACC Stop&Go adjusts to the set distance (distance 1). The speedometer mark for the Active Cruise Control with Stop&Go function also lights up green in the speed reading.
 TE15-0974	Distance control (ranging) active: ACC Stop&Go adjusts to the set distance (distance 2). The speedometer mark for the Active Cruise Control with Stop&Go function also lights up green in the speed reading.

G12 Driver Assistance Systems

19. Cruise Control

Symbols	Explanation
 TE15-0975	<p>Distance control (ranging) active: ACC Stop&Go adjusts to the set distance (distance 3). The speedometer mark for the Active Cruise Control with Stop&Go function also lights up green in the speed reading. Distance 3 is about half the value of the km/h display in metres and is pre-set automatically when the system is first switched on.</p>
 TE15-0976	<p>Distance control (ranging) active: ACC Stop&Go adjusts to the set distance (distance 4). The speedometer mark for the Active Cruise Control with Stop&Go function also lights up green in the speed reading.</p>
 TE15-1034	<p>This symbol is displayed if the distance to the vehicle ahead is too short.</p>

G12 Driver Assistance Systems

19. Cruise Control

19.3.3. System wiring diagram

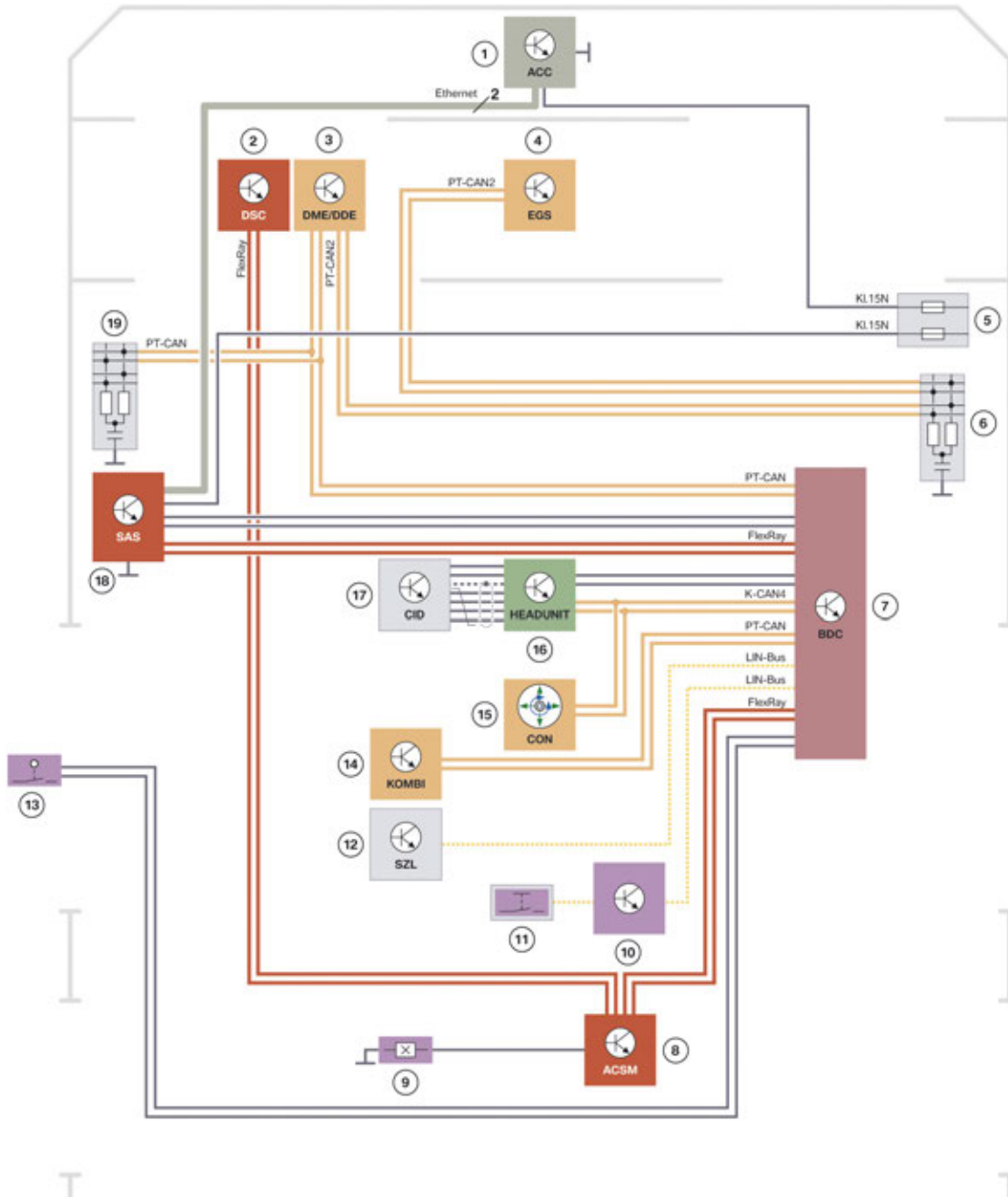

TE15-0520

G12 system wiring diagram for Active Cruise Control with Stop&Go

G12 Driver Assistance Systems

19. Cruise Control

Index	Explanation
1	Active Cruise Control (ACC) Stop&Go
2	Dynamic Stability Control DSC
3	Digital Motor Electronics (DME)
4	Electronic transmission control (EGS)
5	Fuse for front right power distribution box
6	CAN terminator
7	Body Domain Controller (BDC)
8	Advanced Crash Safety Module (ACSM)
9	Seat belt buckle contact, driver's seat
10	Audio control panel
11	Intelligent Safety button
12	Steering column switch cluster (SZL)
13	Door contact, driver's door
14	Instrument panel (KOMBI)
15	Controller (CON)
16	Head Unit High 2 (HU-H2)
17	Central information display (CID)
18	Control unit for optional equipment system (SAS)
19	CAN terminator

G12 Driver Assistance Systems

20. Speed Limit Warning

The driver has the option of setting a speed at which a warning is issued when the system is activated and the preset speed is exceeded.

20.1. Operation

The speed limit warning can be switched on and off in the iDrive menu, as well as the speed setting at which the warning should be issued, by making the following selection via the controller:

- "My Vehicle"
- "Vehicle settings"
- "Speed limit warning"
- "Warning at:"
- turn controller until the desired speed is displayed
- press controller
- speed limit warning is saved.



Speed limit warning display on the CID

G12 Driver Assistance Systems

21. Lateral Guidance Assistants

This increased the speed range in which the system can be used from 40 km/h to 60 km/h.

The below graphic shows when the lateral guidance systems were introduced:



Overview of steering and lane control assistant including traffic jam assistant

Index	System	Functional characteristics of the systems
3	Traffic jam assistant (from 2015 with launch of G12)	<ul style="list-style-type: none"> 0 - 70 km/h Traffic jam following distance control with lane center guidance No road-type restrictions
3	Steering lane keeping assistant (from 2015 with launch of G12)	<ul style="list-style-type: none"> 70 - 210 km/h Lane center guidance No road-type restrictions
4	Active lane keeping assistant with active side collision protection (from 2015 with launch of G12)	<ul style="list-style-type: none"> 30 - 70 km/h (warning in form of single steering wheel pulse) 70 - 210 km/h (corrective steering interventions) Active steering interventions in situations where a collision is imminent No road-type restrictions

The steering and lane control assistant and active lane keeping assistant with active side collision protection have been introduced for the first time in the G12.

G12 Driver Assistance Systems

22. Lane & Traffic Jam Assistant

The lane keeping assistant with traffic jam assistant is part of the Active Driving Assistant Plus optional equipment (OE 5AT).

The system assists the driver in keeping the vehicle in lane by initiating corrective steering interventions if required.



G12 active steering intervention

22.1. Functional principle

Depending on the speed, the system is guided by the lane edges or vehicles driving ahead. The position of the lane edges and the vehicle driving ahead is determined with the help of five radar sensors and the KAFAS stereo camera.

G12 Driver Assistance Systems

22. Lane & Traffic Jam Assistant

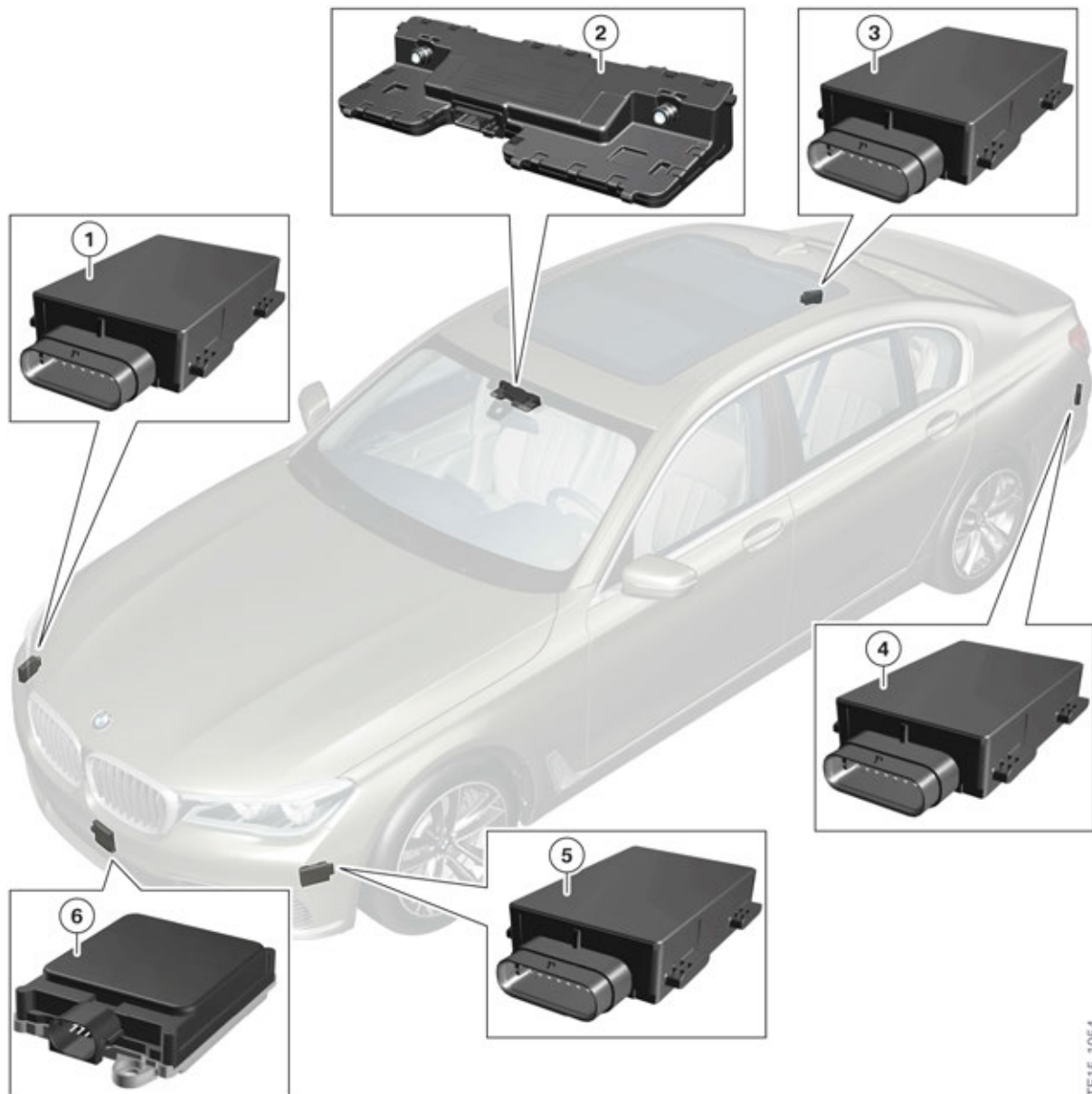

G12 installation locations of radar sensors and KAFAS stereo camera

TE15-1054

Index	Explanation
1	Control unit for radar sensor, right (RSR)
2	KAFAS stereo camera
3	Blind spot detection, right (primary)
4	Blind spot detection, left (secondary)
5	Control unit for radar sensor, left (RSL)
6	Active Cruise Control (ACC) (FRR)

G12 Driver Assistance Systems

22. Lane & Traffic Jam Assistant

The system has two sub-functions: the traffic jam assistant (second generation) and the lane control assistant.

The traffic jam assistant can be used within the speed range of 0 to 70 km/h, the lane control assistant on the other hand from 70 to 210 km/h.

The table below shows an overview of the differences between the two sub-functions:

Traffic Jam Assist	Lane Control Assistant
Speed range 0 - 70 km/h	Speed range 70 - 210 km/h
Corrective steering interventions in the direction of the vehicle driving ahead	Corrective steering interventions in the direction of the center of the lane
Detected lane markings taken into consideration	Gaps in lane markings can be bridged for a limited time by aligning with vehicle ahead

If the traffic jam and lane control assistants are activated, the side collision warning is also interlinked.

22.1.1. Hands-off-Detection

To ensure the driver is alert and able to react, he is urged to always have both hands on the steering wheel when the steering and lane control assistant including traffic jam assistant are activated (established in the German road traffic regulations). If the driver takes both hands off the steering wheel rim, control is stopped after a few seconds during active control and the driver is requested to take over steering.

A capacitive sensor (hands-off detection sensor) with corresponding touch detection electronics in the steering wheel determines whether the steering wheel is being touched.

The electronic touch detection is installed in the steering wheel below the driver's airbag.

G12 Driver Assistance Systems

22. Lane & Traffic Jam Assistant



G12 steering wheel with touch detection control unit

The hands can only be detected on the steering wheel rim, not on the steering wheel spokes, hub or impact plate.

The sensor consists of a mat which is wrapped round the steering wheel rim.

G12 Driver Assistance Systems

22. Lane & Traffic Jam Assistant



TE15-0850

G12 sensor mat for touch detection

Index	Explanation
1	Sensor mat
2	Connection for capacitive touch detection
3	Connection for steering wheel heating

The lane keeping assistant with traffic jam assistant is deactivated a few seconds after a hand is no longer touching the steering wheel rim. In order to be able to use the steering and lane control assistant including traffic jam assistant, the steering wheel must be grasped. When driving with gloves on or with a steering wheel cover fitted, the sensor may not be able to detect contact with the steering wheel, which means the system may not be able to be used.

The diagnosis of the Hands-off-Detection is performed in the Body Domain Controller BDC.

22.1.2. Functional prerequisites

The following prerequisites must be met in order for the steering and lane control assistant including traffic jam assistant to be used:

G12 Driver Assistance Systems

22. Lane & Traffic Jam Assistant

- Speed must be below 210 km/h.
- Above 70 km/h: both lane edges must be detected.
- Below 70 km/h: both lane edges or a vehicle driving ahead must be detected.
- The lane width must be sufficient.
- The vehicle should be positioned as centrally as possible in the lane.
- There must be a sufficient curve radius.
- At least one hand must be on the steering wheel rim.
- The turn indicator must not be activated.
- The camera calibration process must be completed immediately after vehicle delivery.

The active lateral control function with data evaluation of the KAFAS stereo camera is implemented with the assistance of the lane markings identified on the left and right.

In order for the system to be activated, two lane boundary lines must be detected. Below a speed of approximately 70 km/h a vehicle driving ahead in the same lane is sufficient to activate the system.

The system is put in Standby mode if the marginal conditions are not satisfied (e.g. hands not on steering wheel, lane too narrow or dazzling of KAFAS stereo camera). Once all marginal conditions have been met, the system is re-enabled automatically.

To activate the system, the speed of the vehicle is another input quantity that is evaluated. The system uses these values to decide which function is enabled. As mentioned above, the threshold values are set as follows:

- The traffic jam assistant can be enabled within a speed range of 0 to 70 km/h.
- The lane control assistant can be enabled within a speed range of 70 to 210 km/h.

22.1.3. Lane change

For a lane change to be as comfortable as possible, the steering and lane control assistant including traffic jam assistant is put silently into Standby mode when the turn indicator is activated and reactivates itself automatically once the turn indicator is back in its initial position and a lane change has occurred.

22.1.4. Function logic

The main function logic of the lateral guidance is implemented in the optional equipment system (SAS) control unit.

The majority of the data for the function is provided by the KAFAS stereo camera, where algorithms for the lane and object detection run.

Vehicle dynamics data, such as the driving speed, wheel speeds, yaw rate, steering angle, lateral acceleration, longitudinal acceleration, etc., is provided by the rest of the vehicle network via a FlexRay or CAN connection.

A target trajectory (also known as a path curve) is calculated in the optional equipment system (SAS) control unit. This is used to determine whether a steering correction is required.

G12 Driver Assistance Systems

22. Lane & Traffic Jam Assistant

22.1.5. Steering interventions

If the current course of the vehicle deviates too much from the target trajectory (path curve), a steering correction is initiated.

The steering intervention is a corrective measure. This means the driver is not relieved of his duty to steer the vehicle. As the corrective steering interventions are limited to approximately 1.5 m/s^2 based on the lateral acceleration, the system cannot navigate curves above the respective speed-dependent curve radius without the driver's assistance. The driver must therefore steer the vehicle at the same time in order to stay on the roadway.

The target trajectory and required steering corrections are calculated based on the driving speed as follows:

Speed range 0 to 70 km/h:

- The position and previous movements of the vehicle driving ahead are given priority when determining the appropriate steering corrections.
- Detected lane markings are taken into account to avoid unwanted steering corrections that would result in leaving the lane.
- Corrective steering interventions in the direction of the center of the lane are initiated if the vehicle detects there is not a vehicle driving ahead.

Speed range 70 to 130 km/h:

- Corrective steering interventions in the direction of the center of the lane are initiated.
- It is possible to bridge the gap for a limited time where lane markings are not detected by estimating the course of the lane based on the vehicle driving ahead.

Speed range 130 to 210 km/h:

- Corrective steering interventions in the direction of the center of the lane are initiated.
- For safety reasons above a driving speed of approximately 130 km/h the course of the lane is **not** estimated using the vehicle driving ahead.

The vehicle driving ahead is given priority as the "correction target" at speeds ranging between approximately 0 and 70 km/h due to the limited detection of lane markings.

In traffic jams or slow-moving traffic following distances are often extremely small (< 10 m) due to tailgating and lanes ahead are often partially covered due to staggered driving.

This means the KAFAS stereo camera is unable to correctly interpret the lane markings in some cases.

When classifying the object driving ahead, vehicles such as motorbikes are not used as the "correction target".

Steering torque

The driving dynamics function software in the Dynamic Stability Control (DSC) control unit calculates a target steering torque based on the curve nominal value. The target steering torque is then converted to an engine torque by the Electronic Power Steering (EPS), which finally results in a steering wheel movement at the wheels.

G12 Driver Assistance Systems

22. Lane & Traffic Jam Assistant

The maximum steering torque has been set in such a way that it can always be overruled by the driver and therefore steering past the maximum steering torque is possible.

22.1.6. Operation

The system is switched on via the traffic jam assistant button on the multifunction steering wheel (MFL).

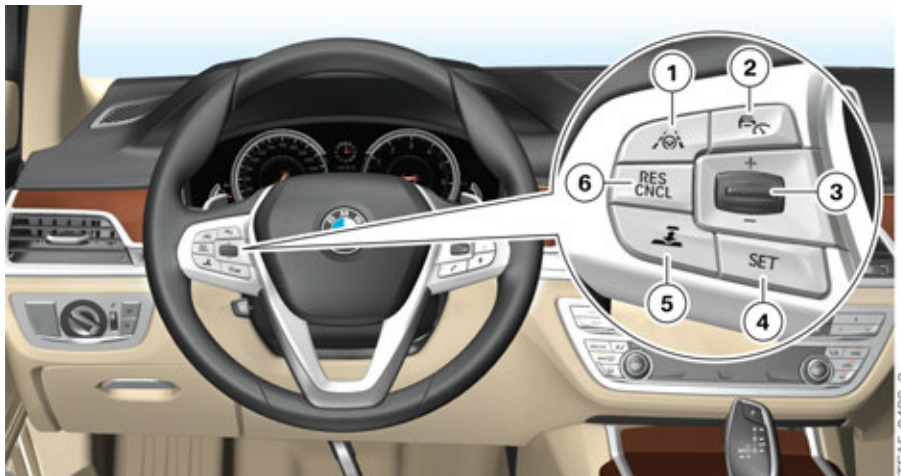





G12 buttons for ACC Stop&Go with Active Driving Assistant Plus optional equipment (OE 5AT)

Index	Explanation
1	Button for activating or deactivating the lane keeping assistant with traffic jam assistant
2	Button for activating or deactivating ACC Stop & Go
3	Rocker switch for changing the set speed
4	“SET” button for setting the speed of cruise control
5	Button for adjusting the distance of the driver's vehicle to the vehicle driving ahead
6	Button for calling up a saved set speed/temporarily switching off the cruise control

G12 Driver Assistance Systems

22. Lane & Traffic Jam Assistant

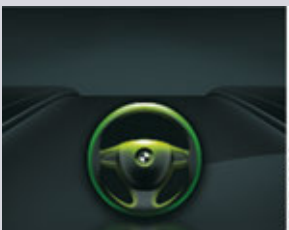
Displays

Symbols	Explanation
 <p>TE15-0966</p>	<p>Grey steering wheel symbol:</p> <ul style="list-style-type: none"> The system has been interrupted and will not make any further steering wheel movements. The system is in Standby mode. Once the system conditions are met, the system reactivates itself automatically.
 <p>TE15-0962</p>	<p>Green steering wheel symbol and lane edges:</p> <ul style="list-style-type: none"> The system assists in keeping the vehicle in the lane.
 <p>TE15-0963</p>	<p>Green steering wheel symbol, grey lane edges:</p> <ul style="list-style-type: none"> No lane edges detected. The vehicle follows the vehicle driving ahead.
 <p>TE15-0964</p>	<p>Yellow steering wheel symbol:</p> <ul style="list-style-type: none"> Request for driver to place hands back on the steering wheel (grasp steering wheel). System continues to be active.
 <p>TE15-0965</p>	<p>Red steering wheel symbol and acoustic signal sounds:</p> <ul style="list-style-type: none"> The system has been interrupted. It will not make any further steering wheel movements.

Configuration options

The driver can change the system settings in the Intelligent Safety configuration menu.

G12 Driver Assistance Systems

22. Lane & Traffic Jam Assistant

22.1.7. System wiring diagram

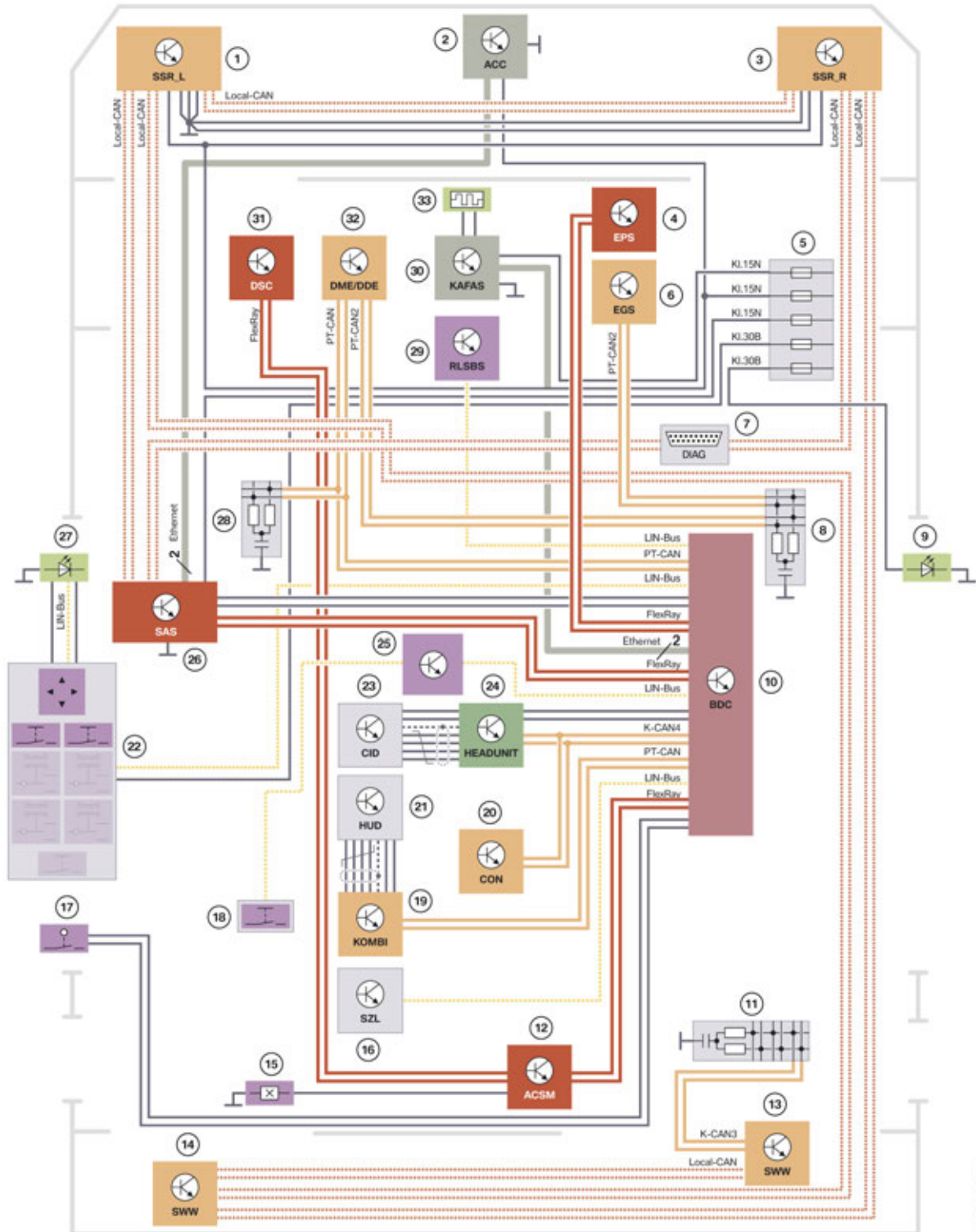

G12 Active Driving Assistant Plus (OE 5AT)/ lane keeping & traffic jam assistant wiring diagram

TE15-0521

G12 Driver Assistance Systems

22. Lane & Traffic Jam Assistant

Index	Explanation
1	Control units for left radar sensor (RSL) (side radar sensor for the front left side collision warning)
2	Active Cruise Control (ACC)
3	Control units for right radar sensor (RSR) (side radar sensor for the front right side collision warning)
4	Electronic Power Steering EPS
5	Fuse for front right power distribution box
6	Electronic transmission control unit (EGS)
7	Diagnostic socket
8	CAN terminator
9	Signal unit (LED) in right mirror glass
10	Body Domain Controller (BDC)
11	CAN terminator
12	Advanced Crash Safety Module (ACSM)
13	Blind spot detection, right (primary)
14	Blind spot detection, left (secondary)
15	Seat belt buckle switch, driver
16	Steering column switch cluster (SZL)
17	Driver's door lock switch
18	Intelligent Safety button
19	Instrument panel KOMBI
20	Controller CON
21	Head-Up Display (HUD)
22	Switch block for driver's door
23	Central information display CID
24	Head Unit High 2 (HU-H2)
25	Audio control panel
26	Control unit for optional equipment system SAS
27	Signal unit (LED) in left mirror glass
28	CAN terminator
29	Rain-light-solar-condensation sensor (RLSBS)
30	KAFAS stereo camera
31	Dynamic Stability Control (DSC)
32	Digital Motor Electronics (DME)
33	KAFAS stereo camera heating

G12 Driver Assistance Systems

22. Lane & Traffic Jam Assistant

22.1.8. Deactivation criteria

The steering and lane control assistant including traffic jam assistant is deactivated automatically in the following situations:

- If the vehicle departs from the detected lane or the lane width does not meet the requirements.
- If the lane edges of the current lane are not detected by the KAFAS stereo camera.
- If no vehicle driving ahead is detected.
- The vehicle is travelling at a speed greater than 210 km/h.
- If the Hands-off-Detection cannot detect the hands (at least one hand) on the steering wheel rim. Switch-off occurs once a defined time threshold (several seconds) has elapsed.
- Due to the radius of the bend in the road, the inner lane edge is no longer detected due to the camera aperture angle.
- Pedestrian protection assumes the operating condition "Fault exists".
- If the turn indicator is on.
- The driver intervenes actively in the steering.
- If over a certain time period no lane edges are detected and there is not a vehicle driving ahead.
- If the driver manually deactivates the DSC (DSC off).
- If there is an intervention from the preventative pedestrian protection.
- After Dynamic Brake Control braking (brake assistant).

22.1.9. Limits of the system

When driving in narrow lanes, e.g. when driving through roadworks or when emergency lanes are formed, the system cannot be activated or used meaningfully.



Due to the limited detection capacity of the KAFAS stereo camera, the driver must remain alert and observant in order to be able to actively intervene at any time so as to avoid the risk of an accident. The system does not relieve the driver of personal responsibility for correctly judging the traffic situation. The driver is solely responsible for the vehicle.

G12 Driver Assistance Systems

23. Active Lane Keeping Assistant

The active lane keeping assistant with active side collision protection is part of the Active Driving Assistant Plus optional equipment (OE 5AT).

The system assists the driver in keeping the vehicle in lane and actively avoiding potential side collisions by initiating corrective steering interventions within a speed range from 70 km/h to 210 km/h. The system endeavours to orient the vehicle in its lane according to the situation and within the framework of the system limits.

The system consists of the following four sub-functions:

- Side collision warning
- Lane departure warning
- Blind Spot Detection

23.1. Side collision warning

The table below shows an overview of the functional characteristics of the "Side collision warning" sub-function:

Speed range	Warning functions	Corrective steering intervention
70 - 210 km/h	<ul style="list-style-type: none"> • Issued if the vehicle detects that it is getting critically close to another vehicle to the side • Physical warning in the form of vibration in the steering wheel using an unbalanced actuator • Visual warning in exterior mirror in the form of the corresponding warning light 	<ul style="list-style-type: none"> • Corrective steering intervention in the direction of the available space on the roadway <p>Requirements:</p> <ul style="list-style-type: none"> • Detected lanes • Sufficient available space on the roadway

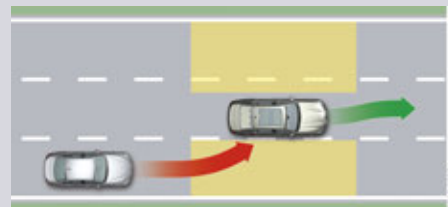

23.1.1. Reduced side collision warning

The reduced side collision warning comes into play if it is not possible to adequately monitor the available space on the roadway or there is no available space on the roadway.

The reduced side collision warning is interlinked with the steering and lane control assistant including traffic jam assistant function.

The table below shows an overview of the functional characteristics of the "Reduced side collision warning" sub-function:

G12 Driver Assistance Systems

23. Active Lane Keeping Assistant

Speed range	Warning function	Corrective steering intervention
30 - 210 km/h	<ul style="list-style-type: none"> Issued if the vehicle detects that it is getting critically close to another vehicle to the side Physical warning in the form of vibration in the steering wheel using an unbalanced actuator Visual warning in exterior mirror in the form of the corresponding warning light 30 - 70 km/h additional warning issued by single steering wheel pulse 	<ul style="list-style-type: none"> A corrective steering intervention is not initiated; instead only a single steering wheel pulse warning is issued in the opposite direction to the detected object the vehicle could collide with

23.2. Lane departure warning

The table below shows an overview of the functional characteristics of the "Lane departure warning" sub-function:

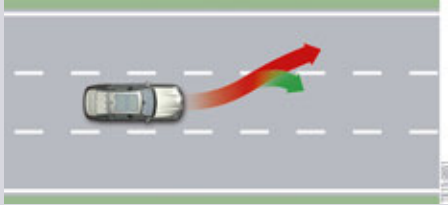
Speed range	Warning function	Corrective steering intervention
70 - 210 km/h	<ul style="list-style-type: none"> Triggered in the event a lane departure is detected by the lane departure warning function. The associated physical warning in the form of a vibration in the steering wheel using an unbalanced actuator is issued and visual warning in the exterior mirror in the form of the corresponding warning light. 	<ul style="list-style-type: none"> Corrective steering intervention in the direction of the original lane if vehicle moves towards neighboring lane <p>Requirements:</p> <ul style="list-style-type: none"> Detected lanes 

G12 Driver Assistance Systems

23. Active Lane Keeping Assistant

23.3. Blind spot detection

The table below shows an overview of the functional characteristics of the "Blind spot detection" sub-function:

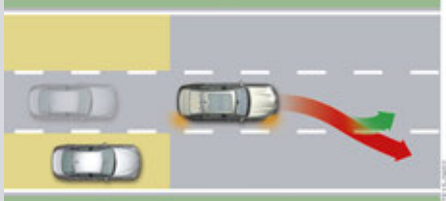
Speed range	Warning function	Corrective steering intervention
70 - 210 km/h	<ul style="list-style-type: none"> Triggered in the event a lane change that could result in a collision is detected by the lane departure warning function. The associated physical warning in the form of a vibration in the steering wheel using an unbalanced actuator is issued and visual warning in the exterior mirror in the form of the corresponding warning light. 	<ul style="list-style-type: none"> Corrective steering intervention in the direction of the available space on the roadway when lane change intention is made and neighboring lane is obstructed <p>Prerequisites:</p> <ul style="list-style-type: none"> Detected lanes Sufficient available space on the roadway 

Further information can be found in the system descriptions of the respective sub-functions (see sections 8-10).



The active lane keeping assistant with active side collision protection does not relieve the driver of his overall responsibility for driving the vehicle. Due to the system limits be attentive in order to be able to actively intervene at any time. Otherwise, there is a risk of an accident.



Bayerische Motorenwerke Aktiengesellschaft
Qualifizierung und Training
Röntgenstraße 7
85716 Unterschleißheim, Germany